

UNDERSTAND. INNOVATE. DELIVER.

Merit Medical Systems is a worldwide leader in the development, manufacturing, and distribution of quality medical devices used in interventional and diagnostic procedures. With a global work force and cutting-edge manufacturing facilities equipped with the most advanced technology, Merit Medical consistently delivers quality products that are backed by excellent customer service and professional expertise.

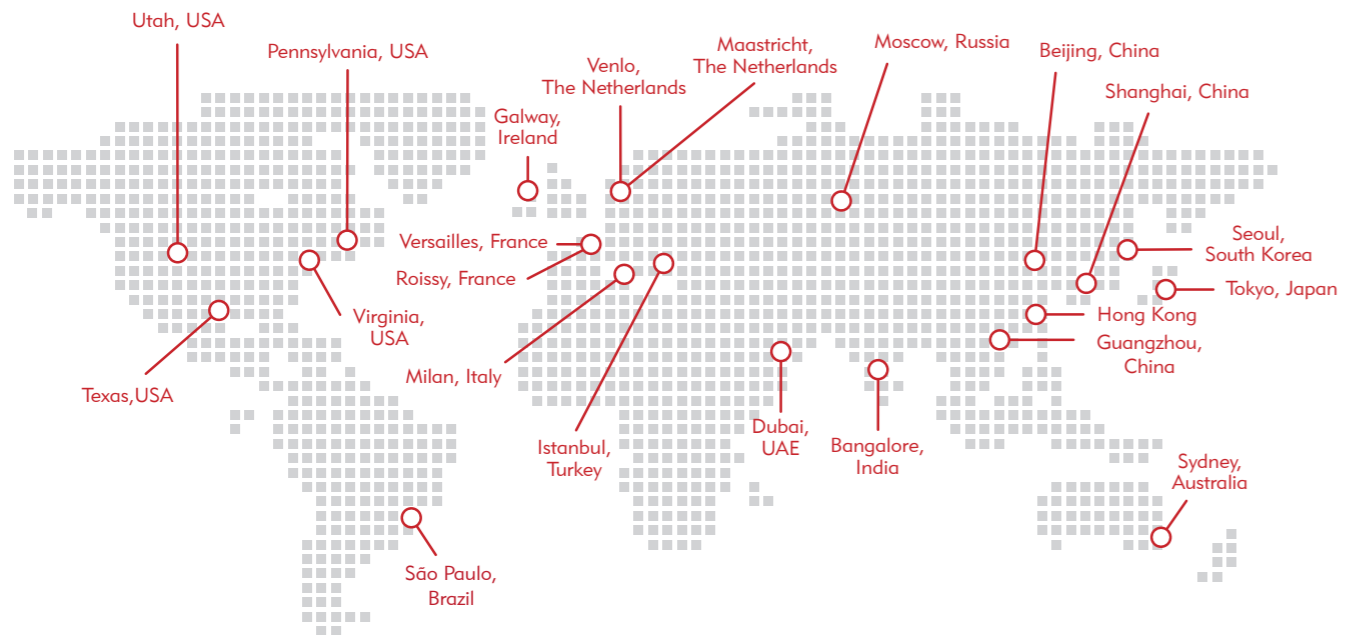

European Corporate Headquarters, Maastricht, The Netherlands

MERITMEDICAL | EMEA

Merit Medical Europe, Middle East & Africa

Amerikalaan 42, 6199 AE Maastricht-Airport, Netherlands
+31 43 358 82 22

Merit Medical Ireland Ltd.

Parkmore Business Park West, Galway, Ireland
+35 39 170 37 33

Merit Medical France

136 Ave. Joseph Kessel, 78960 Voisins Le Bretonneux, France
+33 (0)1 30 57 24 24

Merit Medical Systems, Inc.

1600 West Merit Parkway, South Jordan, UT, 84095 USA
+1 801 253 1600

Asia, Pacific Rim, Latin America, Caribbean & Canada

+1 801 208 4438

Free phone for specific country

Austria
0800 295 374

Belgium
0800 72 906 (Dutch)
0800 73 172 (French)

Denmark
80 88 00 24

Finland
0800 770 586

France
0800 91 60 30

Germany
0800 182 0871

Ireland (Republic)
1800 553 163

Italy
800 897 005

Luxembourg
8002 25 22

Netherlands
0800 022 81 84

Norway
800 11629

Sweden
020 792 445

Sweden
020 792 445

Switzerland
00800 9000 5060

UK
0800 973 115



PERIPHERAL INTERVENTION

PRODUCT CATALOG

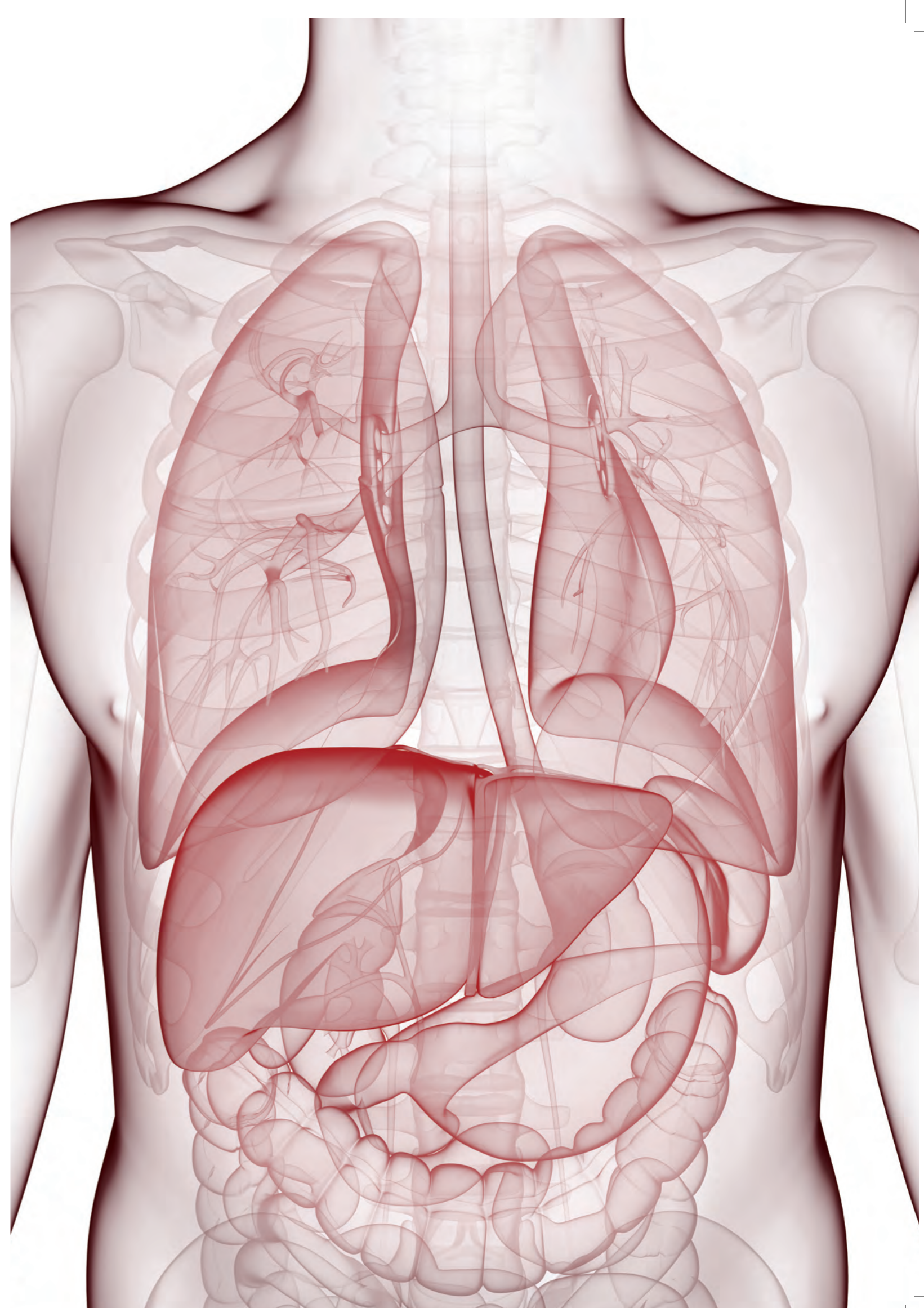
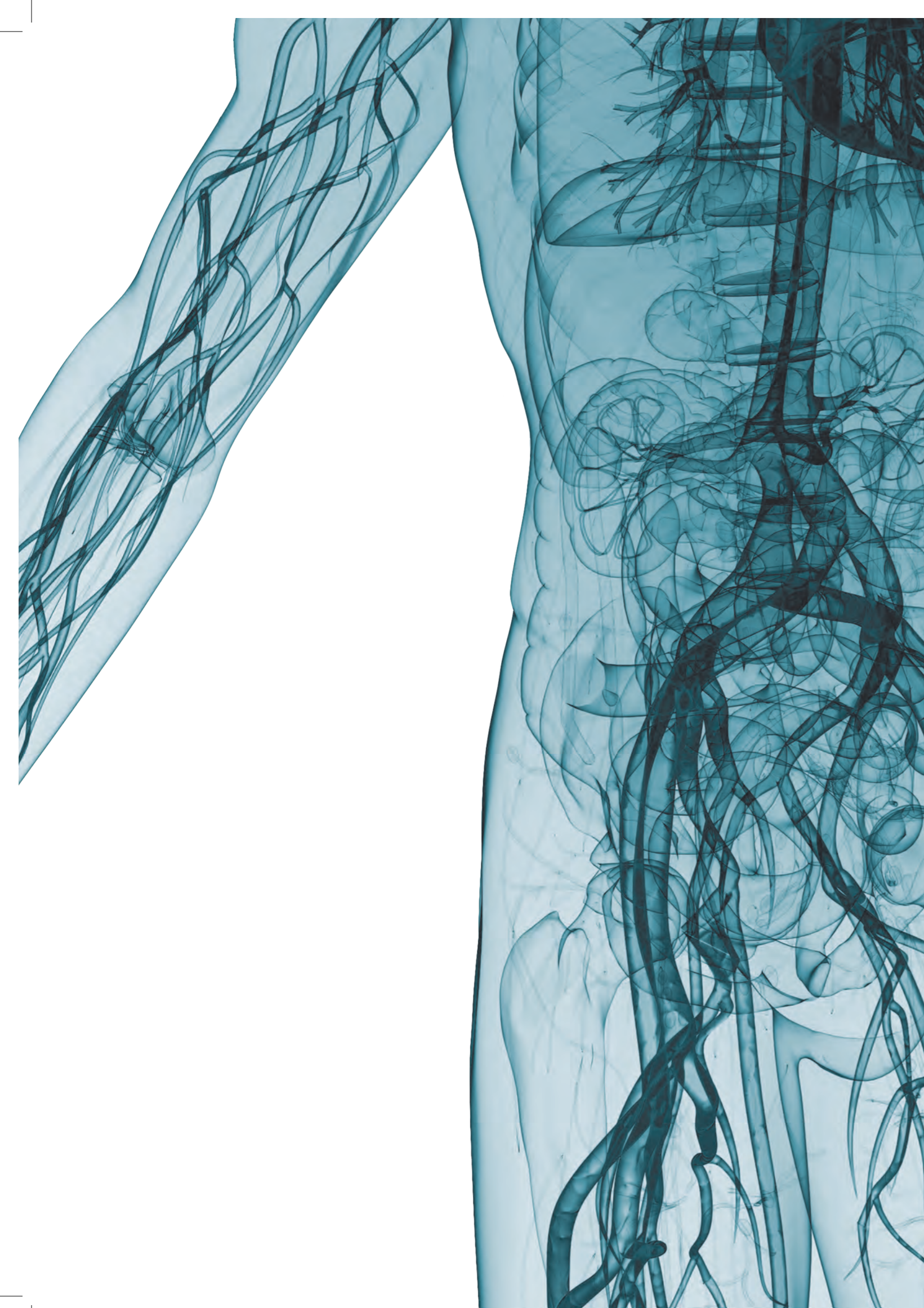

MESSAGE FROM OUR FOUNDER AND CHIEF EXECUTIVE OFFICER

Merit Medical was founded on a strong desire to develop partnerships with healthcare providers. By working closely with you and listening to your challenges, we are able to design, manufacture, and deliver medical devices you can rely on to improve the health and well-being of the patients we mutually serve.

Our Peripheral Intervention catalog is filled with feature-rich product options and the technical information you need to support your purchasing decisions. These products are designed to assist interventional and diagnostic procedures at every step, from access to closure. We are proud of this comprehensive, diverse product portfolio that has been developed to help healthcare providers deliver efficient, patient-focused, and cost-effective care.

Each day we strive to understand, innovate and deliver for our partners in healthcare and the patients we serve.



Fred Lampropoulos
Founder, Chairman & CEO
Merit Medical Systems, Inc.



Understand. Innovate. Deliver.™

ACCESS

NEEDLES

Merit Advance® Angiographic Needles	3
-------------------------------------	---

INTRODUCERS & DILATORS

Merit MAK™ - Mini Access Kit	5
Merit S-MAK™ - Stiffened Mini Access Kit	6
Merit MAK & S-MAK Accessories	7
Prelude® Dilators	7
Vessel Dilators	7
Prelude Sheath Introducers with Marker Tip	8
Prelude Short Sheath Introducers	9
A-S-K Merit Access Safety Kit®	10

ACCESSORIES

BowTie™ Guide Wire Insertion Device	10
Haemostasis Valve Adapter	10

ANGIOGRAPHY

DIAGNOSTIC GUIDE WIRES

InQwire® PTFE Coated Guide Wires	13-14
InQwire PTFE Coated, Fixed Core Guide Wires with Ringmaster™	15

HYDROPHILIC GUIDE WIRES

Merit Laureate® Hydrophilic Guide Wires	15
Tenor® Steerable Micro Guide Wire	17

GUIDE WIRE ACCESSORIES

H2O Torq™ Torque Devices	18
SeaDragon™ Torque Device	18

DIAGNOSTIC PERIPHERAL CATHETERS

Catheter Directory	20
Catheter Shape Illustrations	21-22
Impress®	23-32
Impress Hydrophilic	33-36
Performa®	37-50

FLUID MANAGEMENT & TUBING

High Pressure Flow Control Switch	51
Contrast Transfer (CT) Sets	51

MICROCATHETERS

Merit Maestro® Microcatheters	52
-------------------------------	----

SYRINGES

Medallion® Syringes	53-55
VacLok® Vacuum Pressure Syringes	56

INTERVENTION

DRAINAGE CATHETERS & ACCESSORIES

MAK-NV™ Introducer Systems	59
Valve Adapter for MAK-NV	59
ReSolve® Biliary Locking Drainage Catheters	60
Repositioning Tool for Locking Catheters	60
ReSolve Locking Drainage Catheters	61
ReSolve+™ Locking Drainage Catheters	62
Resolve Locking Drainage Catheter Trays	63
ReSolve Non-Locking Drainage Catheters	64
One-Step™ Centesis Catheters	65
Safety Paracentesis Procedure Tray	66
Thoracentesis and Paracentesis Set	67

CATHETER ACCESSORIES

Revolution™ Catheter Securement Device	68
StayFix® Fixation Device	68

DRAINAGE ACCESSORIES

Merit Drainage Depot™ Drainage Bags	69
Abscess Drainage Kit	69
Drainage Kits	69
VacLok Vacuum Pressure Syringes	70
Marquis® Series Stopcocks	71
Drainage Tubing	71
Connecting Tubes	71

SUPPORT CATHETERS

Merit SureCross™ Support Catheters	72
------------------------------------	----

INFLATION DEVICES

BasixCOMPAK™ Inflation Device	73
BasixTOUCH™ Inflation Device	73
BIG60™ Inflation Device	74
Blue Diamond™ Inflation Device	74

SNARES & ACCESSORIES

EN Snare® Endovascular Snare System	75
ONE Snare® Endovascular Snare System	76
FLO 30™ Tuohy Borst Valved Adapter	76

TABLE OF CONTENTS

INTERVENTION CONTINUED

LONG-TERM HAEMODIALYSIS & PERITONEAL DIALYSIS CATHETERS & ACCESSORIES

Merit Advance® Curved Needles	77
Prelude® Short Sheath Introducers	78
Impress® 30 cm Catheters	79
Centros® & CentrosFLO® Catheters	80
ProGuide™ Chronic Dialysis Catheters & Kits	81-82
OuTake® Catheter Extraction Tool	83
Peritoneal Dialysis Catheters	83
Peritoneal Dialysis Accessories & Implantation Systems	84
Slip-Not® Suture Retention Device	85

THERAPEUTIC INFUSION SYSTEMS

4 French Fountain® Infusion Systems	86
5 French Fountain Infusion Systems	87
Fountain Infusion Catheters	88
Fountain Occluding Wires	89
Squirt® Fluid Dispensing System	89
Pulse Infusion Kits	89-90
Mistique® Infusion Catheters	90

EMBOLOTHERAPY

MICROSPHERES

EmboGold® Microspheres	93
Embosphere® Microspheres	93
Bearing nsPVA® Embolisation Particles	94

DELIVERY SYSTEMS

Merit Maestro® Microcatheters	95
Tenor® Steerable Guide Wires	96
Impress Uterine Artery Catheter	96

ONCOLOGY

MICROSPHERES

HepaSphere™ Microspheres	98
--------------------------	----

COMPLETE PROCEDURAL SOLUTIONS

PROCEDURAL TRAYS, PACKS & KITS

Biopsy Centesis Kits	101
Medicaton Delivery Packs	102
Myelogram Tray	103
Vein Closure Tray	104
Vein Closure Syringe	104
Patient Cover	105
Drape Armour® – Scatter Radiation Drapes	105

SAFETY & WASTE MANAGEMENT

Merit Disposal Depot™ Waste Bags	106-108
----------------------------------	---------

HAEMOSTASIS ACCESSORIES

Clo-Sur P.A.D.® & Clo-Sur PLUS P.A.D.™	109
SafeGuard® Pressure Assisted Device	109
Haemostasis Valve Adapter	110

INDEXES

Index by Catalog Number	111
Index by Product Name	125



PERIPHERAL INTERVENTION

ACCESS

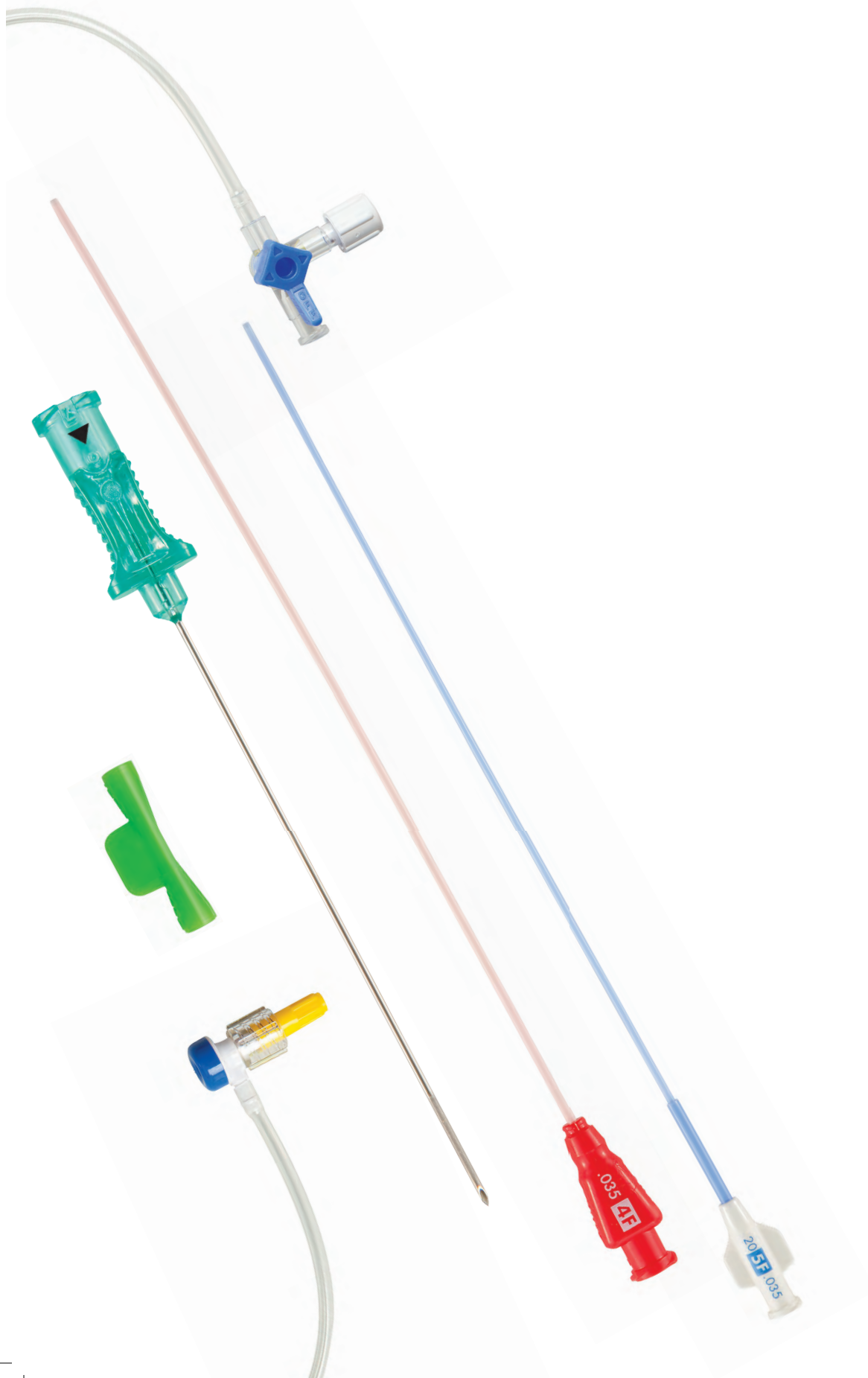

ACCESS

NEEDLES

Merit Advance® Angiographic Needles	3
-------------------------------------	---

INTRODUCERS & DILATORS

Merit MAK™ - Mini Access Kit	5
Merit S-MAK™ - Stiffened Mini Access Kit	6
Merit MAK & S-MAK Accessories	7
Prelude® Dilators	7
Vessel Dilators	7
Prelude Sheath Introducers with Marker Tip	8
Prelude Short Sheath Introducers	9
A-S-K Merit Access Safety Kit®	10

ACCESSORIES

BowTie™ Guide Wire Insertion Device	10
Haemostasis Valve Adapter	10

MERIT ADVANCE® ANGIOGRAPHIC NEEDLES

The Merit Advance angiographic needle has a unique hub design with an ergonomic feel and reference point to orient the bevel. Its increased sharpness facilitates entry into tissue and vessel walls and was designed for smooth guide wire insertion and removal of the needle over the wire.

Catalog Number	Gauge	Wall Thickness	Accepts Guide Wire	Length	Length	Finish
ONE-WALL STYLE NEEDLE						
						
AD18T51W	18	Thin	.038" (0.97 mm)	5.0 cm	2"	Smooth
AD18T71W	18	Thin	.038" (0.97 mm)	7.0 cm	2 3/4"	Smooth
AD18T71W-E	18	Thin	.038" (0.97 mm)	7.0 cm	2 3/4"	Echo
AD18T71WT	18	Thin	.038" (0.97 mm)	7.0 cm	2 3/4"	Smooth
AD18N91W	18	Normal	.038" (0.97 mm)	9.0 cm	3 1/2"	Smooth
AD19U41W	19	Ultra	.035" (0.89 mm)	4.0 cm	1 1/2"	Smooth
AD19U51W	19	Ultra	.035" (0.89 mm)	5.0 cm	2"	Smooth
AD19U71W	19	Ultra	.035" (0.89 mm)	7.0 cm	2 3/4"	Smooth
AD20T41W	20	Thin	.025" (0.64 mm)	4.0 cm	1 1/2"	Smooth
AD20T71W	20	Thin	.025" (0.64 mm)	7.0 cm	2 3/4"	Smooth
AD21T21W	21	Thin	.021" (0.53 mm)	2.5 cm	1"	Smooth
AD21T41W	21	Thin	.021" (0.53 mm)	4.0 cm	1 1/2"	Smooth
AD21T41W-E	21	Thin	.021" (0.53 mm)	4.0 cm	1 1/2"	Echo
AD21T71W	21	Thin	.021" (0.53 mm)	7.0 cm	2 3/4"	Smooth
AD21T71W-E	21	Thin	.021" (0.53 mm)	7.0 cm	2 3/4"	Echo
AD21T91W	21	Thin	.021" (0.53 mm)	9.0 cm	3 1/2"	Smooth
AD21T91W-E	21	Thin	.021" (0.53 mm)	9.0 cm	3 1/2"	Echo
AD21T91R*	21	Thin	.021" (0.53 mm)	9.0 cm	3 1/2"	Smooth
AD21T91RE*	21	Thin	.021" (0.53 mm)	9.0 cm	3 1/2"	Echo

ONE-WALL NEEDLE WITH SELDINGER SHIELD

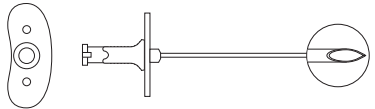
						
AD18T51WS	18	Thin	.038" (0.97 mm)	5.0 cm	2"	Smooth
AD18T71WS	18	Thin	.038" (0.97 mm)	7.0 cm	2 3/4"	Smooth
AD19U71WS	19	Ultra	.035" (0.89 mm)	7.0 cm	2 3/4"	Smooth

ONE-WALL NEEDLE WITH COURNAND SHIELD

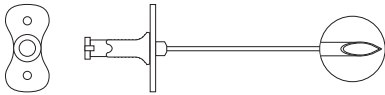
						
AD18T71WC	18	Thin	.038" (0.97 mm)	7.0 cm	2 3/4"	Smooth
AD19U41WC	19	Ultra	.035" (0.89 mm)	4.0 cm	1 1/2"	Smooth
AD19U71WC	19	Ultra	.035" (0.89 mm)	7.0 cm	2 3/4"	Smooth
AD21T41WC	21	Thin	.038" (0.97 mm)	4.0 cm	1 1/2"	Smooth

*Available 10 per box, 4 boxes per case; all other needles packaged 25 per box, 4 boxes per case.



AD21T71W-E

Merit Advance® Angiographic Needle
One-wall style needle, 21 gauge, with
echo-enhanced finish



AD18T51WS

Merit Advance® Angiographic Needle
One-wall style needle with
Seldinger shield, 18 gauge, with
smooth finish



AD18T71WC

Merit Advance® Angiographic Needle
One-wall style needle with
Courmand shield, 18 gauge, with
smooth finish

MERIT MAK™ - MINI ACCESS KITS

The Merit MAK kits allow you to start small, minimising bleeding and trauma to the surrounding tissue. Kits are available in 4F and 5F sizes and include the coaxial introducer/dilator pair, 21 gauge needle and 0.018" (0.46 mm) guide wire.

For your convenience, all kit components are available separately. Merit MAK guide wires are available in many configurations to meet specific clinical needs. Guide wires are packaged in a fully enclosed hoop to ensure they are protected and ready for use.

KIT INCLUDES:

- Coaxial Introducer/Dilator Pair
- 21G Needle
- Guide Wire



Catalog Number	French Size	Length	Guide Wire Diameter/Length	Guide Wire Core/Tip	Needle Gauge/Length	Qty/Box
----------------	-------------	--------	----------------------------	---------------------	---------------------	---------

STANDARD 7 CM NEEDLE KITS

MAK401	4	10 cm	0.018" (0.46 mm) x 40 cm	SS/SS	21G x 7 cm	10
MAK501	5	10 cm	0.018" (0.46 mm) x 40 cm	SS/SS	21G x 7 cm	10
MAK401N	4	10 cm	0.018" (0.46 mm) x 40 cm	NT/PT	21G x 7 cm	10
MAK401NPD	4	10 cm	0.018" (0.46 mm) x 40 cm	NT/PD	21G x 7 cm	10
MAK501N	5	10 cm	0.018" (0.46 mm) x 40 cm	NT/PT	21G x 7 cm	10
MAK501NPD	5	10 cm	0.018" (0.46 mm) x 40 cm	NT/PD	21G x 7 cm	10
MAK501N-15	5	15 cm	0.018" (0.46 mm) x 60 cm	NT/PT	21G x 7 cm	10
MAK405	4	10 cm	0.018" (0.46 mm) x 40 cm	SS/PT	21G x 7 cm	10
MAK405PD	4	10 cm	0.018" (0.46 mm) x 40 cm	SS/PD	21G x 7 cm	10
MAK505	5	10 cm	0.018" (0.46 mm) x 40 cm	SS/PT	21G x 7 cm	10
MAK505PD	5	10 cm	0.018" (0.46 mm) x 40 cm	SS/PD	21G x 7 cm	10

ECHO-ENHANCED 7 CM NEEDLE KITS

MAK401-E	4	10 cm	0.018" (0.46 mm) x 40 cm	SS/SS	21G x 7 cm	10
MAK501-E	5	10 cm	0.018" (0.46 mm) x 40 cm	SS/SS	21G x 7 cm	10
MAK401N-E	4	10 cm	0.018" (0.46 mm) x 40 cm	NT/PT	21G x 7 cm	10
MAK401NPD-E	4	10 cm	0.018" (0.46 mm) x 40 cm	NT/PD	21G x 7 cm	10
MAK501N-E	5	10 cm	0.018" (0.46 mm) x 40 cm	NT/PT	21G x 7 cm	10
MAK501NPD-E	5	10 cm	0.018" (0.46 mm) x 40 cm	NT/PD	21G x 7 cm	10
MAK405-E	4	10 cm	0.018" (0.46 mm) x 40 cm	SS/PT	21G x 7 cm	10
MAK505-E	5	10 cm	0.018" (0.46 mm) x 40 cm	SS/PT	21G x 7 cm	10

ECHO-ENHANCED 4 CM NEEDLE KITS

MAK401-PED	4	10 cm	0.018" (0.46 mm) x 40 cm	SS/SS	21G x 4 cm	10
MAK501-PED	5	10 cm	0.018" (0.46 mm) x 40 cm	SS/SS	21G x 4 cm	10
MAK401N-PED	4	10 cm	0.018" (0.46 mm) x 40 cm	NT/PT	21G x 4 cm	10
MAK501N-PED	5	10 cm	0.018" (0.46 mm) x 40 cm	NT/PT	21G x 4 cm	10

SS = Stainless Steel PT = Platinum Tip NT = Nitinol PD = Palladium Tip

MERIT S-MAK™ - STIFFENED DILATOR MINI ACCESS KITS

The Merit S-MAK provides access to the vascular system and facilitates the placement of 0.035" (0.89 mm) or 0.038" (0.97 mm) guide wires. The S-MAK kits allow you to start small, minimising bleeding and trauma to the surrounding tissue and are especially useful for access through difficult scar tissue. Kits are available in 4F and 5F sizes. For your convenience, all kit components are also available sterile, stand alone.

KIT INCLUDES:

- Coaxial Introducer/Stiffened Dilator Pair
- 21G Echo-Enhanced Needle
- Guide Wire



Catalog Number	French Size	Length	Guide Wire Diameter/Length	Guide Wire Core/Tip	Needle Gauge/Length	Qty/Box
STIFFENED DILATOR KITS WITH ECHO-ENHANCED 7 CM NEEDLE						
S-MAK401	4	10 cm	0.018" (0.46 mm) x 40 cm	SS/SS	21G x 7 cm	10
S-MAK501	5	10 cm	0.018" (0.46 mm) x 40 cm	SS/SS	21G x 7 cm	10
S-MAK401N	4	10 cm	0.018" (0.46 mm) x 40 cm	NT/PT	21G x 7 cm	10
S-MAK401NPD	4	10 cm	0.018" (0.46 mm) x 40 cm	NT/PD	21G x 7 cm	10
S-MAK501NPD	4	10 cm	0.018" (0.46 mm) x 40 cm	NT/PD	21G x 7 cm	10
S-MAK501N	5	10 cm	0.018" (0.46 mm) x 40 cm	NT/PT	21G x 7 cm	10
S-MAK501N-15	5	15 cm	0.018" (0.46 mm) x 60 cm	NT/PT	21G x 7 cm	10
S-MAK405	4	10 cm	0.018" (0.46 mm) x 40 cm	SS/PT	21G x 7 cm	10
S-MAK505	5	10 cm	0.018" (0.46 mm) x 40 cm	SS/PT	21G x 7 cm	10

MERIT MAK™ & S-MAK™ KITS WITH BOWTIE™ GUIDE WIRE INSERTION DEVICE

MAK401NBT	4	10 cm	0.018" (0.46 mm) x 40 cm	NT/PT	21G x 7 cm	10
MAK501NBT	5	10 cm	0.018" (0.46 mm) x 40 cm	NT/PT	21G x 7 cm	10
MAK401NPDBT	4	10 cm	0.018" (0.46 mm) x 40 cm	NT/PD	21G x 7 cm	10
MAK501NPDBT	5	10 cm	0.018" (0.46 mm) x 40 cm	NT/PD	21G x 7 cm	10
MAK401NEBT*	4	10 cm	0.018" (0.46 mm) x 40 cm	NT/PT	21G x 7 cm	10
MAK501NEBT*	5	10 cm	0.018" (0.46 mm) x 40 cm	NT/PT	21G x 7 cm	10
MAK401NPDEBT*	4	10 cm	0.018" (0.46 mm) x 40 cm	NT/PD	21G x 7 cm	10
MAK501NPDEBT*	5	10 cm	0.018" (0.46 mm) x 40 cm	NT/PD	21G x 7 cm	10
S-MAK401NBT*	4	10 cm	0.018" (0.46 mm) x 40 cm	NT/PT	21G x 7 cm	10
S-MAK501NBT*	5	10 cm	0.018" (0.46 mm) x 40 cm	NT/PT	21G x 7 cm	10
S-MAK401NPDBT*	4	10 cm	0.018" (0.46 mm) x 40 cm	NT/PD	21G x 7 cm	10
S-MAK501NPDBT*	5	10 cm	0.018" (0.46 mm) x 40 cm	NT/PD	21G x 7 cm	10
S-MAK501N15BT*	5	15 cm	0.018" (0.46 mm) x 60 cm	NT/PT	21G x 7 cm	10

SS = Stainless Steel PT = Platinum Tip NT = Nitinol PD = Palladium Tip

*Echo-enhanced needle

MERIT MAK™ & S-MAK™ ACCESSORIES

Catalog Number	French Size	Length	Guide Wire Diameter/Length	Guide Wire Core/Tip	Needle Gauge/Length	Qty/Box
COAXIAL INTRODUCER/DILATOR PAIRS (INDIVIDUALLY POUCHED)						
MAK4F-10	4	10 cm	-	-	-	5
MAK5F-10	5	10 cm	-	-	-	5
MAK5F-15	5	15 cm	-	-	-	5
S-MAK4F-10	4	10 cm	(with stiffened dilator)	-	-	5
S-MAK5F-10	5	10 cm	(with stiffened dilator)	-	-	5
S-MAK5F-15	5	15 cm	(with stiffened dilator)	-	-	5

GUIDE WIRES (CONTAINED IN A HOOP AND INDIVIDUALLY POUCHED)

MAK001	-	-	0.018" (0.46 mm) x 40 cm	SS/SS	-	10
K001N	-	-	0.018" (0.46 mm) x 40 cm	NT/PT	-	10
MAK001N-60	-	-	0.018" (0.46 mm) x 60 cm	NT/PT	-	10
MAK001N-80	-	-	0.018" (0.46 mm) x 80 cm	NT/PT	-	10
MAKNTPD	-	-	0.018" (0.46 mm) x 40 cm	NT/PD	-	10
MAK005	-	-	0.018" (0.46 mm) x 40 cm	SS/PT	-	10
MAK005-60	-	-	0.018" (0.46 mm) x 60 cm	SS/PT	-	10
MAKSSPD	-	-	0.018" (0.46 mm) x 40 cm	SS/PD	-	10

NEEDLES (INDIVIDUALLY POUCHED)

AD21T21W	-	-	-	-	21G X 2.5 cm	25
AD21T41W	-	-	-	-	21G X 4 cm	25
AD21T71W	-	-	-	-	21G X 7 cm	25
AD21T91W	-	-	-	-	21G X 9 cm	25
AD21T41W-E*	-	-	-	-	21G X 4 cm	25
AD21T71W-E*	-	-	-	-	21G X 7 cm	25
AD21T91W-E*	-	-	-	-	21G X 9 cm	25

SS = Stainless Steel PT = Platinum Tip NT = Nitinol PD = Palladium Tip

* Echo-enhanced needle

PRELUDE® DILATORS

The Prelude® Dilator may be used with any Prelude Sheath Introducer in lengths of 4 cm, 7 cm, and 11 cm. The dilators are packaged individually for your convenience; 10 per box.

Catalog Number	French Size	Length	Maximum Guide Wire	Hub Colour
PD4F035	4	16 cm	0.035" (0.89 mm)	red
PD5F038	5	16 cm	0.038" (0.97 mm)	gray
PD6F038	6	16 cm	0.038" (0.97 mm)	green
PD7F038	7	16 cm	0.038" (0.97 mm)	orange
PD8F038	8	16 cm	0.038" (0.97 mm)	blue

VESSEL DILATORS

Merit Medical's Vessel Dilators allow you to pre-dilate access site when needed. Dilators are packaged individually for your convenience. Packaged in pouch; 10 per box.

Catalog Number	French Size	Length	Recommended Guide Wire
3339-21	5	20 cm	.035" (0.89 mm)
3339-31	4	20 cm	.035" (0.89 mm)
3339-41	6	20 cm	.038" (0.97 mm)
3339-51	5	20 cm	.038" (0.97 mm)



PRELUDE® SHEATH INTRODUCERS WITH MARKER TIP

The Prelude Sheath Introducers with Marker Tip are available in 11 cm (with Prelude PRO polypropylene tubing) and 23 cm (standard Prelude tubing). The sheaths have a highly radiopaque marker tip allowing for increased visibility of the sheath tip under fluoroscopy. Products are available with and without double ended, stainless steel guide wire.



Catalog Number	French Size	Length	Guide Wire Diameter/Length	Hub Colour
PRO-4F-11-035MT	4	11 cm	0.035" (0.89 mm) x 50 cm	red
PRO-5F-11-035MT	5	11 cm	0.035" (0.89 mm) x 50 cm	gray
PRO-6F-11-035MT	6	11 cm	0.035" (0.89 mm) x 50 cm	green
PRO-7F-11-035MT	7	11 cm	0.035" (0.89 mm) x 50 cm	orange
PRO-8F-11-035MT	8	11 cm	0.035" (0.89 mm) x 50 cm	blue
PRO-5F-11-038MT	5	11 cm	0.038" (0.97 mm) x 50 cm	gray
PRO-6F-11-038MT	6	11 cm	0.038" (0.97 mm) x 50 cm	green
PRO-7F-11-038MT	7	11 cm	0.038" (0.97 mm) x 50 cm	orange
PRO-8F-11-038MT	8	11 cm	0.038" (0.97 mm) x 50 cm	blue
PRO-4F-11MT	4	11 cm	N/A	red
PRO-5F-11MT	5	11 cm	N/A	gray
PRO-6F-11MT	6	11 cm	N/A	green
PRO-7F-11MT	7	11 cm	N/A	orange
PRO-8F-11MT	8	11 cm	N/A	blue
PSI-4F-23-035MT	4	23 cm	0.035" (0.89 mm) x 80 cm	red
PSI-5F-23-035MT	5	23 cm	0.035" (0.89 mm) x 80 cm	gray
PSI-6F-23-035MT	6	23 cm	0.035" (0.89 mm) x 80 cm	green
PSI-7F-23-035MT	7	23 cm	0.035" (0.89 mm) x 80 cm	orange
PSI-8F-23-035MT	8	23 cm	0.035" (0.89 mm) x 80 cm	blue
PSI-5F-23-038MT	5	23 cm	0.038" (0.97 mm) x 80 cm	gray
PSI-6F-23-038MT	6	23 cm	0.038" (0.97 mm) x 80 cm	green
PSI-7F-23-038MT	7	23 cm	0.038" (0.97 mm) x 80 cm	orange
PSI-8F-23-038MT	8	23 cm	0.038" (0.97 mm) x 80 cm	blue
PSI-4F-23MT	4	23 cm	N/A	red
PSI-5F-23MT	5	23 cm	N/A	gray
PSI-6F-23MT	6	23 cm	N/A	green
PSI-7F-23MT	7	23 cm	N/A	orange
PSI-8F-23MT	8	23 cm	N/A	blue

Packaged in holster; 5 per box.

PRELUDE® SHORT SHEATH INTRODUCERS

The Prelude Short Sheath Introducer provides access to dialysis fistulas and grafts. Can be used for declot, angioplasty and thrombolysis procedures, as well as temporary haemodialysis. These sheaths offer excellent transitions and material characteristics for easy and smooth access. Will accommodate flow rates up to 600 mL/min. Includes removable stopcock.



Catalog Number	French Size	Length	Guide Wire Diameter/Length	Needle Gauge/Length	Hub Colour	Qty/Box
PSS-5F-4-018MT*	5	4 cm	0.018" (0.46 mm) x 40 cm	21G x 4 cm	gray	5
PSS-6F-4-018MT	6	4 cm	0.018" (0.46 mm) x 40 cm	21G x 4 cm	green	5
PSS-7F-4-018MT	7	4 cm	0.018" (0.46 mm) x 40 cm	21G x 4 cm	orange	5
PSS-8F-4-018MT	8	4 cm	0.018" (0.46 mm) x 40 cm	21G x 4 cm	blue	5
PSS-5F-4-035MT**	5	4 cm	0.035" (0.89 mm) x 50 cm	–	gray	5
PSS-6F-4-035MT	6	4 cm	0.035" (0.89 mm) x 50 cm	–	green	5
PSS-7F-4-035MT	7	4 cm	0.035" (0.89 mm) x 50 cm	–	orange	5
PSS-8F-4-035MT	8	4 cm	0.035" (0.89 mm) x 50 cm	–	blue	5
PSS-5F-4-038MT**	5	4 cm	0.038" (0.97 mm) x 50 cm	–	gray	5
PSS-6F-4-038MT	6	4 cm	0.038" (0.97 mm) x 50 cm	–	green	5
PSS-7F-4-038MT	7	4 cm	0.038" (0.97 mm) x 50 cm	–	orange	5
PSS-8F-4-038MT	8	4 cm	0.038" (0.97 mm) x 50 cm	–	blue	5
PSS-5F-4MT	5	4 cm	N/A	–	gray	5
PSS-6F-4MT	6	4 cm	N/A	–	green	5
PSS-7F-4MT	7	4 cm	N/A	–	orange	5
PSS-8F-4MT	8	4 cm	N/A	–	blue	5

* 0.018" guide wire is stainless steel with straight stainless steel flexible tip.

** 0.035" and 0.038" guide wires are stainless steel; double ended (3 mm J and floppy).

A-S-K MERIT ACCESS SAFETY KIT®

The A-S-K Merit Access Safety Kit incorporates new shielded technology that helps minimise the risk of sharps injuries associated with gaining vascular access. Packaged 25 units per box, 4 boxes per case.

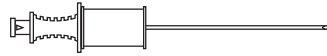
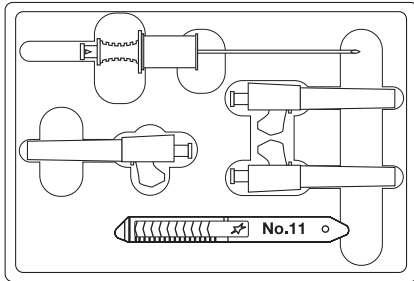

(1) 18G 2 3/4" (7 cm) SecureLoc® Safety Introducer Needle

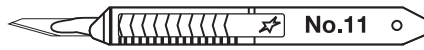

(1) #11 Futura® Safety Scalpel

Catalog Number ASK200

Not available in countries where CE mark is required.

SecureLoc® is a registered trademark of Bard Access System, Inc.

In addition to a safety introducer needle and safety scalpel, the kit contains the following items:

- (1) 18G 1" (2.5 cm) shielded hypodermic needle
- (1) 25G 1" (2.5 cm) shielded hypodermic needle
- (1) 22G 1 1/2" (3.8 cm) shielded hypodermic needle

BOWTIE™ GUIDE WIRE INSERTION DEVICE

The BowTie Guide Wire Insertion Device is an elegant solution to the problem of aligning devices with micro guide wires. Simply insert your device, such as a mini access introducer, in one end of the BowTie and then place over your micro guide wire. After alignment, the BowTie is easily removed through a specially designed, tear-away slit. Packaged individually; 20 units per box.



Catalog Number BT101

Easy – Insert the device halfway into the BowTie.

Quick – Place the BowTie and device over the proximal end of the guide wire.

Efficient – Remove the BowTie after "making ends meet."

HAEMOSTASIS VALVE ADAPTER

Minimises blood loss during the introduction of catheters or devices into the vasculature. Provides a side arm and 3-way stopcock to facilitate aspiration or infusion. May be used with devices that are 8F or smaller. Packaged 10 per box.

Catalog Number HVA-100





PERIPHERAL INTERVENTION

ANGIOGRAPHY

ANGIOGRAPHY

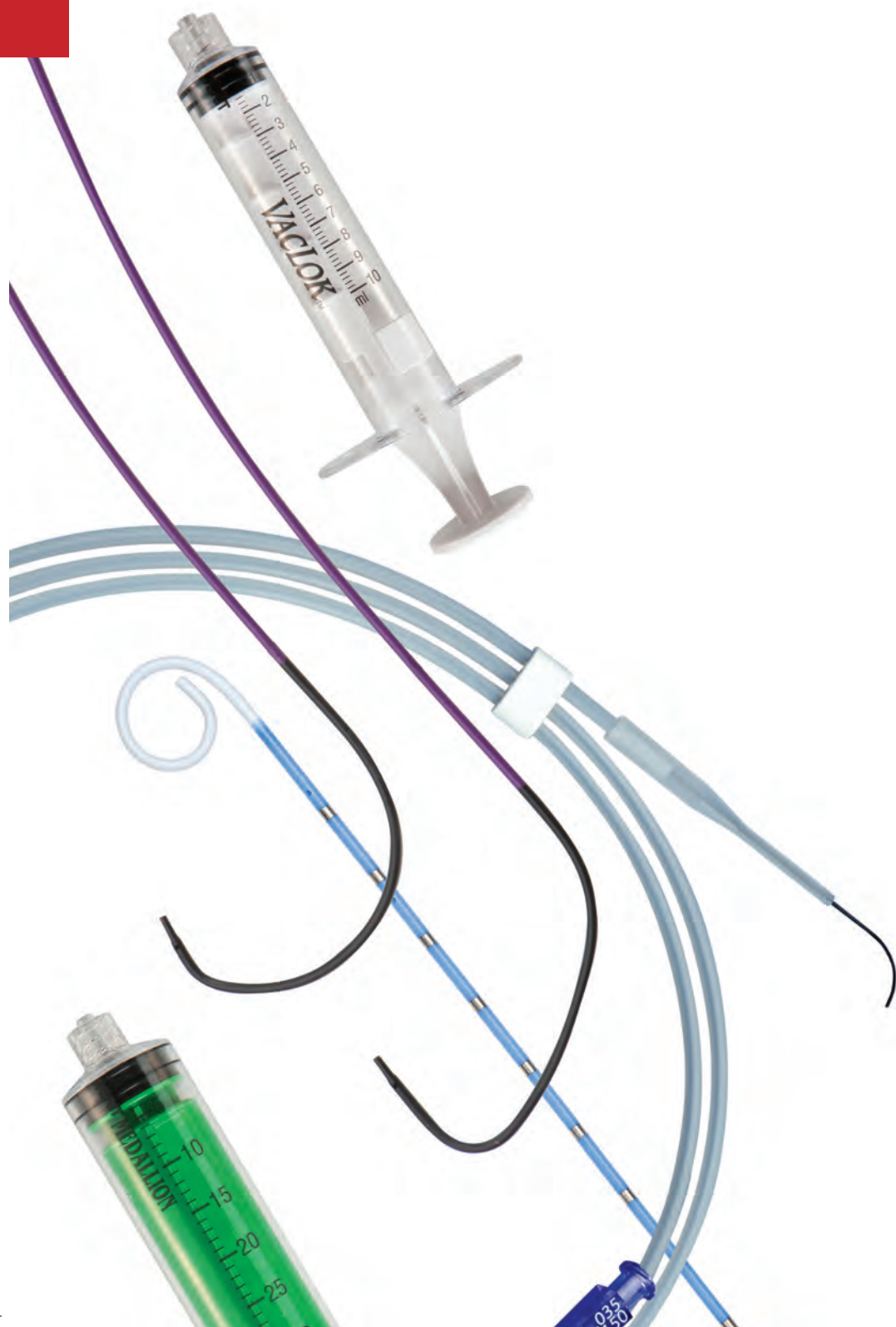

DIAGNOSTIC GUIDE WIRES

InQwire® PTFE Coated Guide Wires	13
InQwire PTFE Coated, Fixed Core Guide Wires with Ringmaster™	15

HYDROPHILIC GUIDE WIRES

Merit Laureate® Hydrophilic Guide Wires	15
Tenor® Steerable Micro Guide Wire	17

GUIDE WIRE ACCESSORIES

H2O Torq™ Torque Devices	18
SeaDragon™ Torque Device	18

DIAGNOSTIC PERIPHERAL CATHETERS

<i>Catheter Directory</i>	20
<i>Catheter Shape Illustrations</i>	21-22
Impress®	23-32
Impress Hydrophilic	33-36
Performa®	37-50

FLUID MANAGEMENT & TUBING

High Pressure Flow Control Switch	51
Contrast Transfer (CT) Sets	51

MICROCATHETERS

Merit Maestro® Microcatheters	53
-------------------------------	----

SYRINGES

Medallion® Syringes	54
Medallion Sword Handle Syringes	54
Medallion Frosted Field Syringes & Pens	54
Custom Medallion Syringes	55
VacLok® Vacuum Pressure Syringes	56

INQWIRE® PTFE COATED GUIDE WIRES

The InQwire guide wire is precoated with PTFE over the entire wire surface for smooth, consistent coverage that resists flaking. Less friction means increased trackability, lubricity, and durability. Its precise J-tip memory does not require reloading the J straightener and the tight guide wire tolerances ensure catheter and sheath compatibility. The InQwire is also available with heparin coating to minimise clot formation.

Catalog Number	Description	Size	Length cm	Core	Heparin Coated	# Per Box
STRAIGHT-TIP WIRES						
6676-A1	Straight	0.018" (0.46 mm)	150	F		10
6676-B3	Straight	0.018" (0.46 mm)	180	F		5
6676-C1	Straight	0.021" (0.53 mm)	150	F		10
6676-D3	Straight	0.021" (0.53 mm)	180	F		5
IQ35F150S	Straight	0.035" (0.89 mm)	150	F		10
IQH35F150S	Straight	0.035" (0.89 mm)	150	F	H**	10
IQ35F260S	Straight	0.035" (0.89 mm)	260	F		10
6690-41	Straight	0.035" (0.89 mm)	150	M		10
6690-61	Straight	0.038" (0.97 mm)	150	M		10
IQ38F150S	Straight	0.038" (0.97 mm)	150	F		10
IQ38F260S	Straight	0.038" (0.97 mm)	260	F		10
IQ35F150NLT	Newton; LT (13.5 cm)	0.035" (0.89 mm)	150	F		10
IQH35F150NLT	Newton; LT (13.5 cm)	0.035" (0.89 mm)	150	F	H**	10
IQ35F150NLLT	Newton; LLT (18.5 cm)	0.035" (0.89 mm)	150	F		10
IQH35F150NLLT	Newton; LLT (18.5 cm)	0.035" (0.89 mm)	150	F	H**	10
IQ35F150NLLLT	Newton; LLLT(23.5 cm)	0.035" (0.89 mm)	150	F		10
6677-B1	Newton; LT (18.5 cm) 3 mm J	0.035" (0.89 mm)	150	F		10
IQ35F80B	Bentson (23 cm)	0.035" (0.89 mm)	80	F		10
IQ35F150B	Bentson (23 cm)	0.035" (0.89 mm)	150	F		10
IQH35F150B	Bentson (23 cm)	0.035" (0.89 mm)	150	F	H**	5 /10*
IQ35F180B	Bentson (23 cm)	0.035" (0.89 mm)	180	F		10
IQH35F180B	Bentson (23 cm)	0.035" (0.89 mm)	180	F	H**	5
IQ35F260B	Bentson (23 cm)	0.035" (0.89 mm)	260	F		10
IQ38F150B	Bentson (23 cm)	0.038" (0.97 mm)	150	F		10
IQH38F150B	Bentson (23 cm)	0.038" (0.97 mm)	150	F	H**	10
IQ35F150BC	Bentson C (15 cm)	0.035" (0.89 mm)	150	F		10
IQ35F150BST	Bentson ST (10 cm)	0.035" (0.89 mm)	150	F		10
IQ35F180BST	Bentson ST (10 cm)	0.035" (0.89 mm)	180	F		10
IQ38F150BST	Bentson ST (10 cm)	0.038" (0.97 mm)	150	F		10
6680-61	Super Stiff	0.035" (0.89 mm)	80	F		10
6680-51	Super Stiff	0.035" (0.89 mm)	100	F		10
6680-11	Super Stiff	0.035" (0.89 mm)	150	F		10
6680-71	Super Stiff	0.035" (0.89 mm)	180	F		10
6680-23	Super Stiff	0.035" (0.89 mm)	260	F		5
6680-31	Super Stiff	0.038" (0.97 mm)	150	F		10
6680-43	Super Stiff	0.038" (0.97 mm)	180	F		5
ROSEN-TIP WIRES						
IQ35F80J1O5RS	1.5mm J (R)	0.035" (0.89 mm)	80	F		10
IQ35F150J1O5RS	1.5mm J (R)	0.035" (0.89 mm)	150	F		10
IQ35F180J1O5RS*	1.5mm J (R)	0.035" (0.89 mm)	180	F		5 /10*
6609-33	1.5mm J (R)	0.035" (0.89 mm)	260	F		5
IQ38F150J1O5RS	1.5mm J (R)	0.038" (0.97 mm)	150	F		10

All "J" tip fixed core wires are finger-straightenable. FB = Firm Body, ST = Short Taper, H = Heparin Coating, R = Rosen, F = Fixed Core, M = Moveable Core, TC = Tapered Core

*New guide wire configurations packaged 10 per box. Original guide wires packaged 5 per box.

**Heparin coated wires do not have CE Marking.



InQwire® Diagnostic Guide Wire

Catalog Number	Description	Size	Length cm	Core	Heparin Coated	# Per Box
J-TIP WIRES						
IQ35F150J1O5	1.5mm J	0.035" (0.89 mm)	150	F		10
IQH35F150J1O5	1.5mm J	0.035" (0.89 mm)	150	F	H**	10
6693-A1	1.5mm J	0.035" (0.89 mm)	150	M		10
IQ35F180J1O5	1.5mm J	0.035" (0.89 mm)	180	F		10
IQ35F210J1O5	1.5mm J	0.035" (0.89 mm)	210	F		10
IQ35F260J1O5	1.5mm J Standard	0.035" (0.89 mm)	260	F		10
IQ35F260J1O5F	1.5mm J FB	0.035" (0.89 mm)	260	F		10
6682-K1	3 mm J	0.018" (0.46 mm)	150	F		10
6682-L3	3 mm J	0.018" (0.46 mm)	180	F		5
6682-M1	3 mm J	0.021" (0.53 mm)	150	F		10
6682-N3	3 mm J	0.021" (0.53 mm)	180	F		5
6682-E1	3 mm J	0.025" (0.64 mm)	150	F		10
IQ35F80J3	3 mm J	0.035" (0.89 mm)	80	F		10
IQH35F150J3	3 mm J	0.035" (0.89 mm)	150	F	H**	10
IQ35F180J3*	3 mm J	0.035" (0.89 mm)	180	F		5/10*
IQ35F260J3	3 mm J	0.035" (0.89 mm)	260	F		10
6693-41	3 mm J	0.035" (0.89 mm)	150	M		10
6693-71	3 mm J	0.035" (0.89 mm)	150	M	H**	10
6647-11	3 mm J 7 cm TC	0.035" (0.89 mm)	145	M		10
IQ38F150J3	3 mm J	0.038" (0.97 mm)	150	F		10
IQH38F150J3	3 mm J	0.038" (0.97 mm)	150	F	H**	10
IQ38F260J3	3 mm J	0.038" (0.97 mm)	260	F		10
6693-61	3 mm J	0.038" (0.97 mm)	150	M		10
6684-61	3 mm J TC	0.038" (0.97 mm)	150	M		10
IQ35F150J3F	3 mm J FB	0.035" (0.89 mm)	150	F		10
IQH35F150J3F	3 mm J FB	0.035" (0.89 mm)	150	F	H**	10
IQ35F180J3F	3 mm J FB	0.035" (0.89 mm)	180	F		10
IQH35F180J3F	3 mm J FB	0.035" (0.89 mm)	180	F	H**	5
IQ38F150J3F	3 mm J FB	0.038" (0.97 mm)	150	F		10
IQH38F150J3F	3 mm J FB	0.038" (0.97 mm)	150	F	H**	10
IQ38F180J3F	3 mm J FB	0.038" (0.97 mm)	180	F		10
IQ35F150J6	6 mm J	0.035" (0.89 mm)	150	F		10
IQH35F70J6	6 mm J	0.035" (0.89 mm)	70	F	H**	10
6694-21	6 mm J	0.035" (0.89 mm)	150	M		10
IQ38F150J6	6 mm J	0.038" (0.97 mm)	150	F		10
IQH38F70J6	6 mm J	0.038" (0.97 mm)	70	F	H**	10
IQ35F150J15	15 mm J	0.035" (0.89 mm)	150	F		10
IQH35F150J15	15 mm J	0.035" (0.89 mm)	150	F	H**	10
IQ38F150J15	15 mm J	0.038" (0.97 mm)	150	F		10
8820-B1	15 mm J	0.035" (0.89 mm)	150	M		10
FIXED CORE, DOUBLE-ENDED						
IQ35F150J105S	1.5 mm J/Straight	.035" (0.89 mm)	150	F		10
IQ35F150J3S	3 mm J/Straight	.035" (0.89 mm)	150	F		10
IQH35F150J3S	3 mm J/Straight	.035" (0.89 mm)	150	F	H**	10
IQ35F150J3SHD	3 mm J/Straight/Heavy Duty	.035" (0.89 mm)	150	F		10

All "J" tip fixed core wires are finger-straightenable. FB = Firm Body, ST = Short Taper, H = Heparin Coating, R = Rosen, F = Fixed Core, M = Moveable Core, TC = Tapered Core

*New guide wire configurations packaged 10 per box. Original guide wires packaged 5 per box.

**Heparin coated wires do not have CE Marking.

NOTE: Guide wire catalog numbers in **BOLD TYPE** are available for immediate delivery. Please allow up to eight weeks delivery for others (minimum quantities required).

INQWIRE® PTFE COATED, FIXED CORE GUIDE WIRES WITH RINGMASTER™

Catalog Number	Description	Size	Length cm	Core	# Per Box
----------------	-------------	------	-----------	------	-----------

STRAIGHT-TIP WIRES

IQR35F150B	Bentson (23 cm)	.035" (0.89 mm)	150	F	10
IQR35F150BST	Bentson Short Taper (10 cm)	.035" (0.89 mm)	150	F	10

J - TIP WIRES

IQR35F150J3	J 3 mm	.035" (0.89 mm)	150	F	10
IQR35F260J3	J 3 mm	.035" (0.89 mm)	260	F	10
IQR35F150J3F	J 3 mm/Firm	.035" (0.89 mm)	150	F	10
IQR38F150J3	J 3 mm	.038" (0.97 mm)	150	F	10
IQR38F150J3F	J 3 mm/Firm	.038" (0.97 mm)	150	F	10

FIXED CORE: DOUBLE ENDED

IQR35F150J3S	J 3 mm/Straight	.035" (0.89 mm)	150	F	10
--------------	-----------------	-----------------	-----	---	----

Heparin coating not available with InQwire guide wires packaged in Ringmaster.



Ringmaster™
Guide Wire Basin

ANGIOGRAPHY

MERIT LAUREATE® HYDROPHILIC GUIDE WIRES

The Merit Laureate Hydrophilic Guide Wire facilitates the placement of devices during diagnostic and interventional navigating tortuous vessels. The hydrophilic coating offers enduring lubricity and consistent surface coating adhesion. The Merit Laureate was designed to reduce wire whipping, minimise friction, and to promote rapid catheter exchanges.

Catalog Number	Description	Size	Length cm	Core	# Per Box
----------------	-------------	------	-----------	------	-----------

STANDARD WIRES

LWSTDA35150	Standard/Angled	0.035" (0.89 mm)	150	F	5
LWSTDA35180	Standard/Angled	0.035" (0.89 mm)	180	F	5
LWSTDA3880	Standard/Angled	0.038" (0.97 mm)	80	F	5
LWSTDA38120	Standard/Angled	0.038" (0.97 mm)	120	F	5
LWSTDA38150	Standard/Angled	0.038" (0.97 mm)	150	F	5
LWSTDA38180	Standard/Angled	0.038" (0.97 mm)	180	F	5
LWSTDS3580	Standard/Straight	0.035" (0.89 mm)	80	F	5

LWSTDS35150	Standard/Straight	0.035" (0.89 mm)	150	F	5
LWSTDS35180	Standard/Straight	0.035" (0.89 mm)	180	F	5
LWSTDS35220	Standard/Straight	0.035" (0.89 mm)	220	F	5
LWSTDS38150	Standard/Straight	0.038" (0.97 mm)	150	F	5
LWSTDS38180	Standard/Straight	0.038" (0.97 mm)	180	F	5

LWSTDA35260EX	Standard/Angled/Exchange	0.035" (0.89 mm)	260	F	5
LWSTDS35260EX	Standard/Straight/Exchange	0.035" (0.89 mm)	260	F	5
LWSTDA38260EX	Standard/Angled/Exchange	0.038" (0.97 mm)	260	F	5
LWSTDS38260EX	Standard/Straight/Exchange	0.038" (0.97 mm)	260	F	5

MERIT LAUREATE® HYDROPHILIC GUIDE WIRES

Catalog Number	Description	Size	Length cm	Core	# Per Box
STIFF WIRES					
LWSTFA3580	Stiff/Angled	0.035" (0.89 mm)	80	F	5
LWSTFA35150	Stiff/Angled	0.035" (0.89 mm)	150	F	5
LWSTFA35180	Stiff/Angled	0.035" (0.89 mm)	180	F	5
LWSTFA35220	Stiff/Angled	0.035" (0.89 mm)	220	F	5
LWSTFA35260EX	Stiff/Angled/Exchange	0.035" (0.89 mm)	260	F	5
LWSTFA3880	Stiff/Angled	0.038" (0.97 mm)	80	F	5
LWSTFA38150	Stiff/Angled	0.038" (0.97 mm)	150	F	5
LWSTFA38180	Stiff/Angled	0.038" (0.97 mm)	180	F	5
LWSTFS3580	Stiff/Straight	0.035" (0.89 mm)	80	F	5
LWSTFS35150	Stiff/Straight	0.035" (0.89 mm)	150	F	5
LWSTFS35180	Stiff/Straight	0.035" (0.89 mm)	180	F	5
LWSTFS35220	Stiff/Straight	0.035" (0.89 mm)	220	F	5
LWSTFS35260EX	Stiff/Straight/Exchange	0.035" (0.89 mm)	260	F	5
LWSTFS38150	Stiff/Straight	0.038" (0.97 mm)	150	F	5
LWSTFS38180	Stiff/Straight	0.038" (0.97 mm)	180	F	5



Catalog Number	Description	Size	Length cm	Core	# Per Box
SMALL DIAMETER SPECIALTY WIRE					
LWSTDA1880	Standard/Angled	0.018" (0.46 mm)	80	F	5
LWSTDA18150	Standard/Angled	0.018" (0.46 mm)	150	F	5
LWSTDA18180	Standard/Angled	0.018" (0.46 mm)	180	F	5
LWSTDA18260EX	Standard/Angled/Exchange	0.018" (0.46 mm)	260	F	5
LWSTDS18150	Standard/Straight	0.018" (0.46 mm)	150	F	5
LWSTDS18180	Standard/Straight	0.018" (0.46 mm)	180	F	5
LWSTDS18260EX	Standard/Straight/Exchange	0.018" (0.46 mm)	260	F	5
LWSTDA25150	Standard/Angled	0.025" (0.64 mm)	150	F	5
LWSTDA25180	Standard/Angled	0.025" (0.64 mm)	180	F	5
LWSTDA25260EX	Standard/Angled/Exchange	0.025" (0.64 mm)	260	F	5
LWSTDS25150	Standard/Straight	0.025" (0.64 mm)	150	F	5
LWSTDS25180	Standard/Straight	0.025" (0.64 mm)	180	F	5
LWSTDS25260EX	Standard/Straight/Exchange	0.025" (0.64 mm)	260	F	5

More options available through Merit's Cardiac Intervention catalog. Ask for more details.

TENOR® STEERABLE MICRO GUIDE WIRES

The Tenor Steerable Micro Guide Wire offers exceptional pushability and torqueability to facilitate precise navigation in challenging anatomy during embolic procedures. Packaged with an insertion tool and torque device.

Catalog Number	Description	Size	Length cm	Tip Material	Core	# Per Box
TNR2411	Angled Tip	0.014" (0.36 mm)	165	Platinum Coiled	F	1
TNR2412	Straight Tip	0.014" (0.36 mm)	165	Platinum Coiled	F	1
TNR2811	Angled Tip	0.018" (0.46 mm)	165	Platinum Coiled	F	1
TNR2812	Straight Tip	0.018" (0.46 mm)	165	Platinum Coiled	F	1

ANGIOGRAPHY

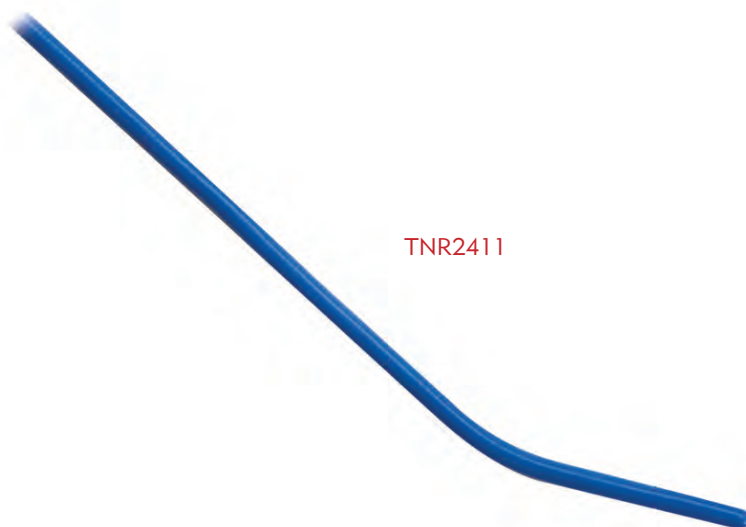

H2O TORQ™

The H2O Torq is an ergonomic torque device operable with one hand, designed to enhance manipulation of the guide wire tip. The single component plastic design can be used on hydrophilic or PTFE-coated wires and allows easy reposition and removal for rapid device exchanges. Packaged individually, 10 units per box.



TD200

Catalog Number	Description
TD100	Orange device; Guide wires from .025" (0.64 mm) to .040" (1.02 mm)
TD200	Yellow device; Guide wires from .010" (0.25mm) to .020" (0.51mm)

SEADRAGON™ GUIDE WIRE TORQUE DEVICE

The SeaDragon is an ergonomic torque device operable with one hand, designed to enhance manipulation of the guide wire tip. The single component plastic design can be used on hydrophilic or PTFE-coated wires and allows easy reposition and removal for rapid device exchanges. Packaged individually, 10 units per box.



Catalog Number	Description
TD500	Guide wires from .018" (0.46 mm) to .038" (0.97 mm)



PERIPHERAL INTERVENTION

DIAGNOSTIC PERIPHERAL CATHETERS

ANGIOGRAPHY

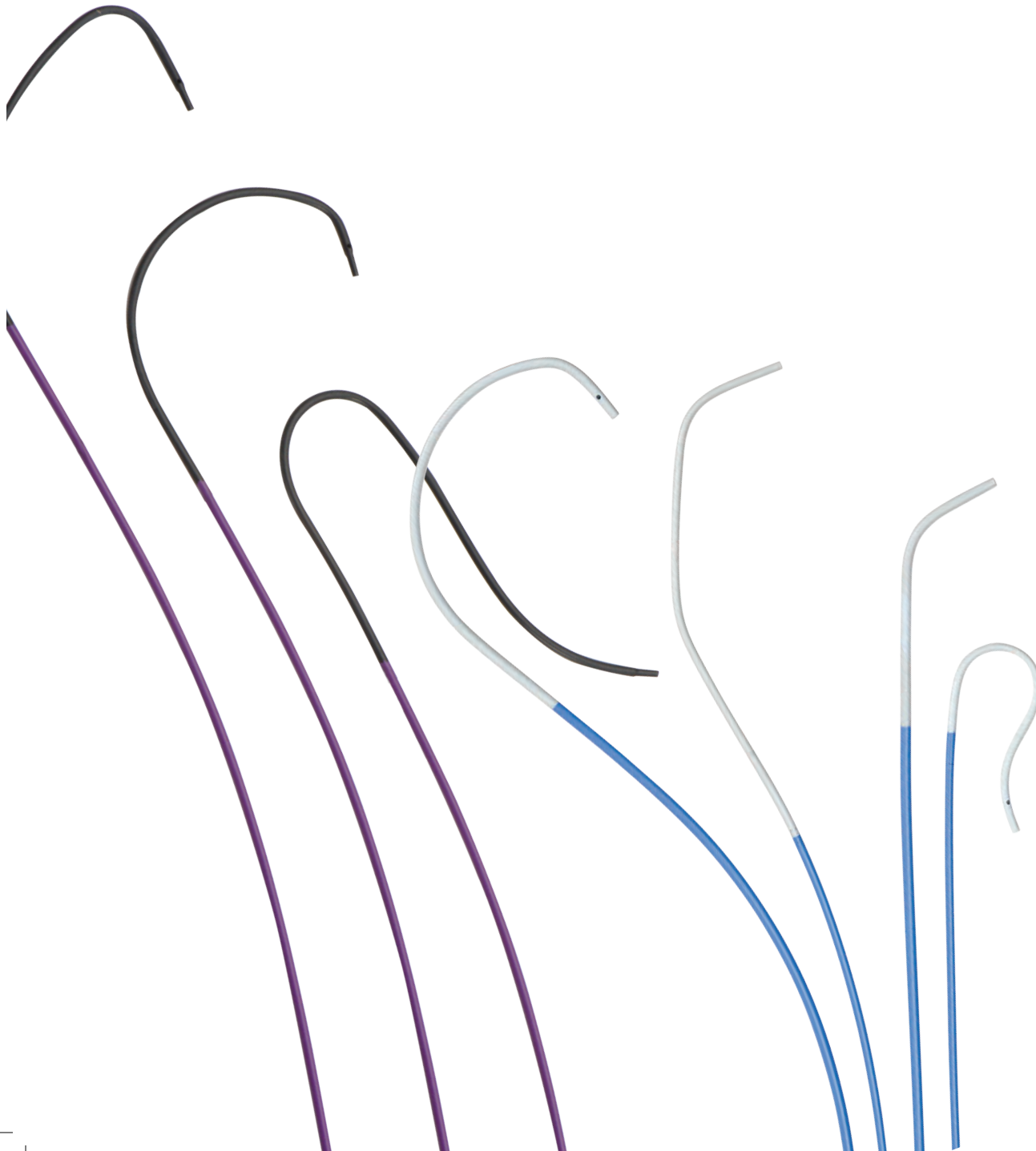

DIAGNOSTIC PERIPHERAL CATHETERS

<i>Catheter Shape Illustrations</i>	21-22	KA2	34
		Mani	34
		Multipurpose	34
		RBI	35
		Simmons	35
		Modified Hook	35
		Straight Selective	36
		Vertebral	36
		PERFORMA®	
		Headhunter	37
		Newton	38
		Bentson	39
		Mani	39
		Vertebral	39
		Modified Cerebral	40
		Berenstein	40
		Straight Selective	40
		MW2	41
		Osborn	41
		Hook	41
		Modified Hook Selective	42
		Simmons	42
		Cobra	43
		Shepherd Hook	44
		Renal Double Curve	44
		Hockey Stick	44
		Amir Motarjeme®	45
		Reuter	45
		Mikaelsson	46
		KA, KA2	46
		DVS A1, DVS A2	46
		Shepherd Flush	47
		Ultra Bolus Flush	47
		Ultra High Flow Pigtail	47
		Pigtail Flush	47
		Straight Flush	48
		Modified Hook Flush	48
		Vessel-Sizing, Adult	49-50
		IMPRESS® HYDROPHILIC	
		Bentson	33
		Berenstein	33
		Cobra	33
		Headhunter	34

- a. HEADHUNTER 1
- b. HEADHUNTER 3
- c. HEADHUNTER 5
- d. HEADHUNTER 6

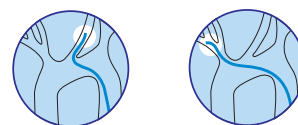
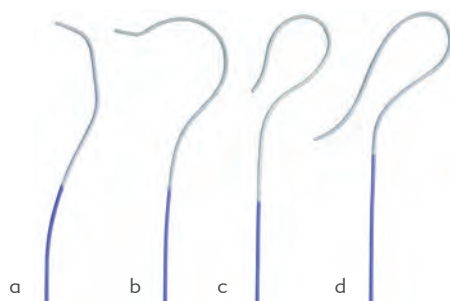

- a. SIMMONS 1
- b. SIMMONS 2
- c. SIMMONS 3
- d. SIMMONS 4
- e. MODIFIED SIMMONS 1.5
- f. MODIFIED SIMMONS

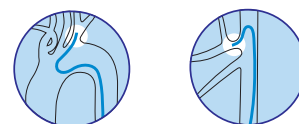
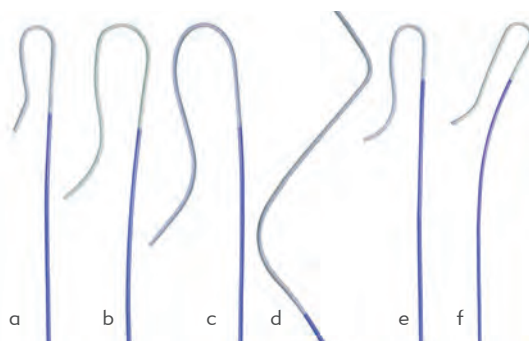

- a. NEWTON 1
- b. NEWTON 2
- c. NEWTON 3
- d. NEWTON 4
- e. NEWTON 5
- f. OSBORN 1
- g. OSBORN 2

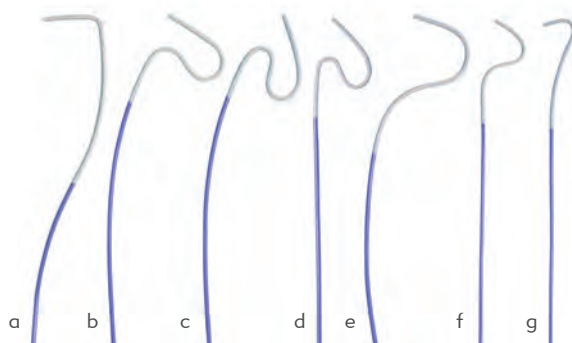

- a. BENTSON 1
- b. BENTSON 2
- c. BENTSON 3
- d. MANI

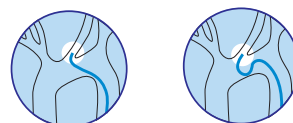
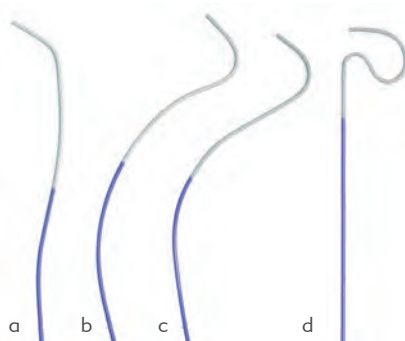

- a. BERENSTEIN
- b. VERTEBRAL
- c. MODIFIED CEREBRAL
- d. MW2
- e. MODIFIED MW2
- f. DVS A1
- g. DVS A2
- h. HOCKEY STICK

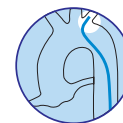
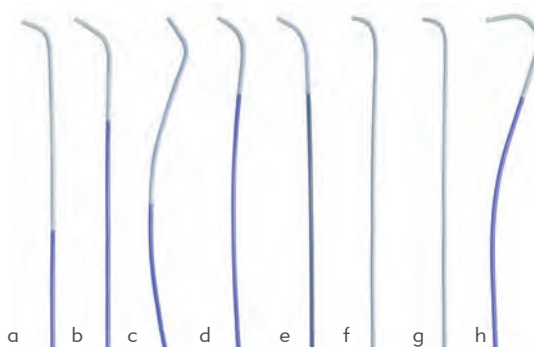

- a. KA
- b. KA2
- c. HOOK 0.8
- d. HOOK 1.0
- e. SHEPHERD HOOK 0.8
- f. SHEPHERD HOOK 1.0
- g. SHEPHERD HOOK 1.0 MOD.
- h. RENAL DOUBLE CURVE

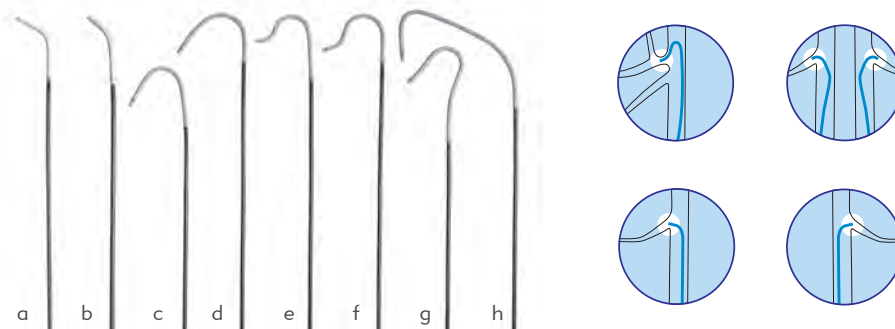

- a. STRAIGHT SELECTIVE
- b. AMIR MOTARJEME®
- c. AMIR MOTAJEME CANE
- d. MOTARJEME EXCHANGE
- e. REUTER
- f. MIKAELSSON

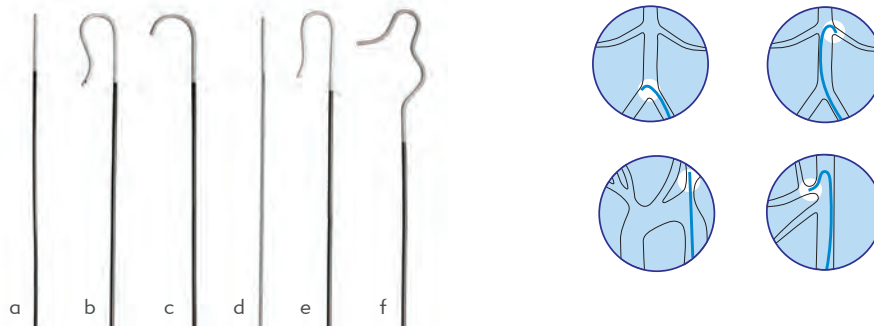

- a. COBRA 1
- b. COBRA 2
- c. COBRA 3



- a. SHEPHERD FLUSH
- b. ULTRA BOLUS FLUSH
- c. MODIFIED BOLUS FLUSH
- d. STANDARD FLUSH
- e. STRAIGHT FLUSH
- f. MODIFIED HOOK FLUSH
- g. RBI
- h. RIM
- i. MINI RIM
- j. MINI RIM ST
- k. UTERINE ARTERY

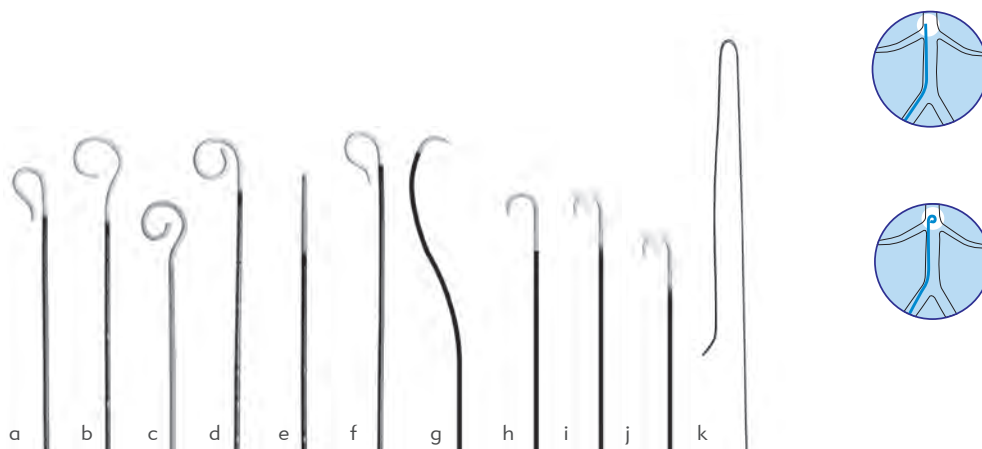

- a. MINI CATHETER
- b. MODIFIED HOOK SELECTIVE 1
- c. MODIFIED HOOK SELECTIVE 2
- d. MODIFIED HOOK SELECTIVE 3

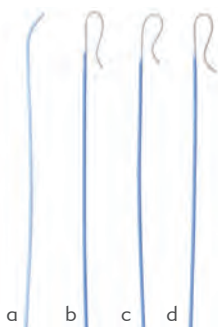

IMPRESS® DIAGNOSTIC PERIPHERAL CATHETERS

The Impress line of diagnostic peripheral catheters has been designed to deliver radiopaque media to selected sites in the vascular system. The tips are tapered to minimise vessel trauma, the accordion hubs are designed to minimise kinking, and the proprietary braid pattern shafts provide maximum flexibility without compromising steerability.

IMPRESS® HEADHUNTER CATHETERS

Catalog Number	French Size	Internal Diameter	Recommended Guide Wire	Length
HEADHUNTER 1				
410035HH1	4	.040"/1.02 mm	.035" (0.89 mm)	100 cm
410038HH1	4	.040"/1.02 mm	.038" (0.97 mm)	100 cm
412535HH1	4	.040"/1.02 mm	.035" (0.89 mm)	125 cm
510035HH1	5	.046"/1.17 mm	.035" (0.89 mm)	100 cm
510038HH1	5	.046"/1.17 mm	.038" (0.97 mm)	100 cm
512535HH1	5	.046"/1.17 mm	.035" (0.89 mm)	125 cm
512538HH1	5	.046"/1.17 mm	.038" (0.97 mm)	125 cm



HEADHUNTER 3				
410035HH3	4	.040"/1.02 mm	.035" (0.89 mm)	100 cm
410038HH3	4	.040"/1.02 mm	.038" (0.97 mm)	100 cm
510035HH3	5	.046"/1.17 mm	.035" (0.89 mm)	100 cm
510038HH3	5	.046"/1.17 mm	.038" (0.97 mm)	100 cm



IMPRESS® NEWTON CATHETERS

Catalog Number	French Size	Internal Diameter	Recommended Guide Wire	Length
NEWTON 1				
410038N1	4	.040"/1.02 mm	.038" (0.97 mm)	100 cm
510038N1	5	.046"/1.17 mm	.038" (0.97 mm)	100 cm
NEWTON 2				
410038N2	4	.040"/1.02 mm	.038" (0.97 mm)	100 cm
510038N2	5	.046"/1.17 mm	.038" (0.97 mm)	100 cm
NEWTON 3				
410038N3	4	.040"/1.02 mm	.038" (0.97 mm)	100 cm
510038N3	5	.046"/1.17 mm	.038" (0.97 mm)	100 cm
NEWTON 4				
410038N4	4	.040"/1.02 mm	.038" (0.97 mm)	100 cm
510038N4	5	.046"/1.17 mm	.038" (0.97 mm)	100 cm

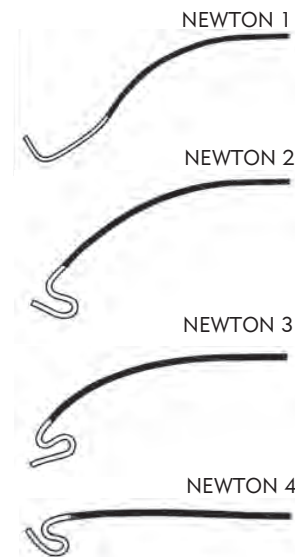

IMPRESS® BENTSON CATHETERS

Catalog Number	French Size	Internal Diameter	Recommended Guide Wire	Length
BENTSON 1				
46535B1	4	.040"/1.02 mm	.035" (0.89 mm)	65 cm
410035B1	4	.040"/1.02 mm	.035" (0.89 mm)	100 cm
410038B1	4	.040"/1.02 mm	.038" (0.97 mm)	100 cm
56535B1	5	.046"/1.17 mm	.035" (0.89 mm)	65 cm
510035B1	5	.046"/1.17 mm	.035" (0.89 mm)	100 cm
510038B1	5	.046"/1.17 mm	.038" (0.97 mm)	100 cm



BENTSON 1

BENTSON 2				
410035B2	4	.040"/1.02 mm	.035" (0.89 mm)	100 cm
510035B2	5	.046"/1.17 mm	.035" (0.89 mm)	100 cm

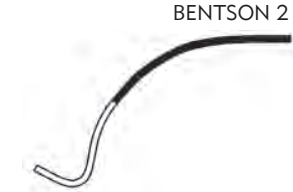

BENTSON 2

IMPRESS® MANI CATHETERS

Catalog Number	French Size	Internal Diameter	Recommended Guide Wire	Length
410035MANI	4	.040"/1.02 mm	.035" (0.89 mm)	100 cm
410038MANI	4	.040"/1.02 mm	.038" (0.97 mm)	100 cm
510035MANI	5	.046"/1.17 mm	.035" (0.89 mm)	100 cm
510038MANI	5	.046"/1.17 mm	.038" (0.97 mm)	100 cm



MANI

IMPRESS® VERTEBRAL CATHETERS

Catalog Number	French Size	Internal Diameter	Recommended Guide Wire	Length
46538VER	4	.040"/1.02 mm	.038" (0.97 mm)	65 cm
410035VER	4	.040"/1.02 mm	.035" (0.89 mm)	100 cm
410038VER	4	.040"/1.02 mm	.038" (0.97 mm)	100 cm
412535VER	4	.040"/1.02 mm	.035" (0.89 mm)	125 cm
56538VER	5	.046"/1.17 mm	.038" (0.97 mm)	65 cm
510035VER	5	.046"/1.17 mm	.035" (0.89 mm)	100 cm
510038VER	5	.046"/1.17 mm	.038" (0.97 mm)	100 cm
512535VER	5	.046"/1.17 mm	.035" (0.89 mm)	125 cm



VERTEBRAL

IMPRESS® MODIFIED CEREBRAL CATHETERS

Catalog Number	French Size	Internal Diameter	Recommended Guide Wire	Length
410035MC	4	.040"/1.02 mm	.035" (0.89 mm)	100 cm
410038MC	4	.040"/1.02 mm	.038" (0.97 mm)	100 cm
510035MC	5	.046"/1.17 mm	.035" (0.89 mm)	100 cm
510038MC	5	.046"/1.17 mm	.038" (0.97 mm)	100 cm



MODIFIED CEREBRAL

IMPRESS® BERENSTEIN CATHETERS

Catalog Number	French Size	Internal Diameter	Length	Recommended Guide Wire
46535BER	4	.040"/1.02 mm	65 cm	.035" (0.89 mm)
46538BER	4	.040"/1.02 mm	65 cm	.038" (0.97 mm)
410035BER	4	.040"/1.02 mm	100 cm	.035" (0.89 mm)
410038BER	4	.040"/1.02 mm	100 cm	.038" (0.97 mm)
412538BER	4	.040"/1.02 mm	125 cm	.038" (0.97 mm)
56535BER	5	.046"/1.17 mm	65 cm	.035" (0.89 mm)
56538BER	5	.046"/1.17 mm	65 cm	.038" (0.97 mm)
510035BER	5	.046"/1.17 mm	100 cm	.035" (0.89 mm)
510038BER	5	.046"/1.17 mm	100 cm	.038" (0.97 mm)
512538BER	5	.046"/1.17 mm	125 cm	.038" (0.97 mm)



IMPRESS® MW2 CATHETERS

Catalog Number	French Size	Internal Diameter	Length	Recommended Guide Wire
44038MW2	4	.040"/1.02 mm	40 cm	.038" (0.97 mm)
56538MW2	5	.046"/1.17 mm	65 cm	.038" (0.97 mm)



IMPRESS® SIMMONS CATHETERS

Catalog Number	French Size	Internal Diameter	Length	Recommended Guide Wire
SIMMONS 1				
46535SIM1	4	.040"/1.02 mm	65 cm	.035" (0.89 mm)
46538SIM1	4	.040"/1.02 mm	65 cm	.038" (0.97 mm)
410035SIM1	4	.040"/1.02 mm	100 cm	.035" (0.89 mm)
410038SIM1	4	.040"/1.02 mm	100 cm	.038" (0.97 mm)
56535SIM1	5	.046"/1.17 mm	65 cm	.035" (0.89 mm)
56538SIM1	5	.046"/1.17 mm	65 cm	.038" (0.97 mm)
510035SIM1	5	.046"/1.17 mm	100 cm	.035" (0.89 mm)
510038SIM1	5	.046"/1.17 mm	100 cm	.038" (0.97 mm)



SIMMONS 2				
46538SIM2	4	.040"/1.02 mm	65 cm	.038" (0.97 mm)
410035SIM2	4	.040"/1.02 mm	100 cm	.035" (0.89 mm)
410038SIM2	4	.040"/1.02 mm	100 cm	.038" (0.97 mm)
56538SIM2	5	.046"/1.17 mm	65 cm	.038" (0.97 mm)
510035SIM2	5	.046"/1.17 mm	100 cm	.035" (0.89 mm)
510038SIM2	5	.046"/1.17 mm	100 cm	.038" (0.97 mm)



MODIFIED SIMMONS				
48035MODS	4	.040"/1.02 mm	80 cm	.035" (0.89 mm)
48038MODS	4	.040"/1.02 mm	80 cm	.038" (0.97 mm)

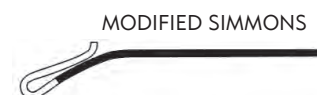

IMPRESS® COBRA CATHETERS

Catalog Number	French Size	Internal Diameter	Length	Recommended Guide Wire	# of Side Ports
COBRA 1 (SIDE HOLES)					
465352CB1	4	.040"/1.02 mm	65 cm	.035" (0.89 mm)	2
465382CB1	4	.040"/1.02 mm	65 cm	.038" (0.97 mm)	2
565352CB1	5	.046"/1.17 mm	65 cm	.035" (0.89 mm)	2
565382CB1	5	.046"/1.17 mm	65 cm	.038" (0.97 mm)	2

COBRA 1 (WITHOUT SIDE HOLES)

46538CB1	4	.040"/1.02 mm	65 cm	.038" (0.97 mm)	-
410038CB1	4	.040"/1.02 mm	100 cm	.038" (0.97 mm)	-
56538CB1	5	.046"/1.17 mm	65 cm	.038" (0.97 mm)	-
510038CB1	5	.046"/1.17 mm	100 cm	.038" (0.97 mm)	-

COBRA 2 (SIDE HOLES)

465352CB2	4	.040"/1.02 mm	65 cm	.035" (0.89 mm)	2
465382CB2	4	.040"/1.02 mm	65 cm	.038" (0.97 mm)	2
565352CB2	5	.046"/1.17 mm	65 cm	.035" (0.89 mm)	2
565382CB2	5	.046"/1.17 mm	65 cm	.038" (0.97 mm)	2

COBRA 2 (WITHOUT SIDE HOLES)

46535CB2	4	.040"/1.02 mm	65 cm	.035" (0.89 mm)	-
46538CB2	4	.040"/1.02 mm	65 cm	.038" (0.97 mm)	-
410038CB2	4	.040"/1.02 mm	100 cm	.038" (0.97 mm)	-
56538CB2	5	.046"/1.17 mm	65 cm	.038" (0.97 mm)	-
510038CB2	5	.046"/1.17 mm	100 cm	.038" (0.97 mm)	-



COBRA 1



COBRA 2

ANGIOGRAPHY

IMPRESS® HOOK CATHETERS

Catalog Number	French Size	Internal Diameter	Length	# of Side Ports
HOOK 0.8				
465352HK0-8	4	.040"/1.02 mm	65 cm	2
565352HK0-8	5	.046"/1.17 mm	65 cm	2
HOOK 1.0				
465352HK1-0	4	.040"/1.02 mm	65 cm	2
565352HK1-0	5	.046"/1.17 mm	65 cm	2



HOOK 0.8



HOOK 1.0

Recommended guide wire is .035" (0.89 mm)

IMPRESS® SHEPHERD HOOK CATHETERS

Catalog Number	French Size	Internal Diameter	Length	# of Side Ports
----------------	-------------	-------------------	--------	-----------------

SHEPHERD HOOK 0.8

465352SH0-8	4	.040"/1.02 mm	65 cm	2
565352SH0-8	5	.046"/1.17 mm	65 cm	2

SHEPHERD HOOK 0.8



SHEPHERD HOOK 1.0

465352SH1-0	4	.040"/1.02 mm	65 cm	2
565352SH1-0	5	.046"/1.17 mm	65 cm	2

SHEPHERD HOOK 1.0



IMPRESS® RENAL DOUBLE CURVE CATHETERS

Catalog Number	French Size	Internal Diameter	Length	# of Side Ports
----------------	-------------	-------------------	--------	-----------------

46535RC	4	.040"/1.02 mm	65 cm	-
465352RC	4	.040"/1.02 mm	65 cm	2
565352RC	5	.046"/1.17 mm	65 cm	2

RENAL DOUBLE CURVE



IMPRESS® AMIR MOTARJEME® CATHETERS

Catalog Number	French Size	Internal Diameter	Length	# of Side Ports
----------------	-------------	-------------------	--------	-----------------

AMIR MOTARJEME

46535MOT	4	.040"/1.02 mm	65 cm	-
410035MOT	4	.040"/1.02 mm	100 cm	-
56535MOT	5	.046"/1.17 mm	65 cm	-
510035MOT	5	.046"/1.17 mm	100 cm	-

MOTARJEME



AMIR MOTARJEME CANE

46535MOTC	4	.040"/1.02 mm	65 cm	-
410035MOTC	4	.040"/1.02 mm	100 cm	-

MOTARJEME CANE



Recommended guide wire is .035" (0.89 mm)

IMPRESS® REUTER CATHETERS

Catalog Number	French Size	Internal Diameter	Recommended Guide Wire	Length
48038RE	4	.040"/1.02 mm	.038" (0.97 mm)	80 cm
58035RE	5	.046"/1.17 mm	.035" (0.89 mm)	80 cm
58038RE	5	.046"/1.17 mm	.038" (0.97 mm)	80 cm



REUTER

IMPRESS® MIKAELSSON CATHETERS

Catalog Number	French Size	Internal Diameter	Recommended Guide Wire	Length
48038MIK	4	.040"/1.02 mm	.038" (0.97 mm)	80 cm
58038MIK	5	.046"/1.17 mm	.038" (0.97 mm)	80 cm



MIKAELSSON

IMPRESS® KA2 CATHETERS

Catalog Number	French Size	Internal Diameter	Recommended Guide Wire	Length
44038KA2	4	.040"/1.02 mm	.038" (0.97 mm)	40 cm
46538KA2	4	.040"/1.02 mm	.038" (0.97 mm)	65 cm
54038KA2	5	.046"/1.17 mm	.038" (0.97 mm)	40 cm
56538KA2	5	.046"/1.17 mm	.038" (0.97 mm)	65 cm



KA2

IMPRESS® UTERINE ARTERY CATHETER

Catalog Number	French Size	Internal Diameter	Recommended Guide Wire	Length
59038UAC	5	.046"/1.17 mm	.038" (0.97 mm)	90 cm



UTERINE ARTERY

IMPRESS® HOCKEY STICK CATHETERS

Catalog Number	French Size	Internal Diameter	Tip Length	Length
410038HS	4	.040"/1.02 mm	100 cm	4.5 cm
510038HS	5	.046"/1.17 mm	100 cm	4.5 cm

Recommended guide wire is .038" (0.97 mm)



HOCKEY STICK

IMPRESS® MODIFIED HOOK SELECTIVE CATHETERS

Catalog Number	French Size	Internal Diameter	Length	# of Side Ports
----------------	-------------	-------------------	--------	-----------------

MODIFIED HOOK 1

48035MHK1	4	.040"/1.02 mm	80 cm	-
58035MHK1	5	.046"/1.17 mm	80 cm	-



MODIFIED HOOK 2

48035MHK2	4	.040"/1.02mm	80 cm	-
58035MHK2	5	.046"/1.17 mm	80 cm	-



MODIFIED HOOK 3

48035MHK3	4	.040"/1.02 mm	80 cm	-
58035MHK3	5	.046"/1.17 mm	80 cm	-

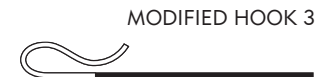

ANGIOGRAPHY

IMPRESS® RBI (RENAL, BIFURCATION, ILIAC) CATHETERS

Catalog Number	French Size	Internal Diameter	Length	# of Side Ports
----------------	-------------	-------------------	--------	-----------------

465354RBI	4	.040"/1.02 mm	65 cm	4
565354RBI	5	.046"/1.17 mm	65 cm	4
56535RBI	5	.046"/1.17 mm	65 cm	-
510035RBI	5	.046"/1.17 mm	100 cm	-
5100354RBI	5	.046"/1.17 mm	100 cm	4



IMPRESS® RIM - MINI RIM SHORT TIP CATHETERS

Catalog Number	French Size	Internal Diameter	Length	# of Side Ports
----------------	-------------	-------------------	--------	-----------------

46535RIM	4	.040"/1.02 mm	65 cm	-
56535RIM	5	.046"/1.17 mm	65 cm	-
56535MRIMST	5	.046"/1.17 mm	65 cm	-



Recommended guide wire is .035" (0.89 mm)



IMPRESS® STRAIGHT SELECTIVE CATHETERS

Catalog Number	French Size	Internal Diameter	Length	Recommended Guide Wire
----------------	-------------	-------------------	--------	------------------------

44035STS	4	.040"/1.02 mm	40 cm	.035" (0.89 mm)
46538STS	4	.040"/1.02 mm	65 cm	.038" (0.97 mm)
411035STS	4	.040"/1.02 mm	110 cm	.035" (0.89 mm)
411038STS	4	.040"/1.02 mm	110 cm	.038" (0.97 mm)
54038STS	5	.046"/1.17 mm	40 cm	.038" (0.97 mm)
56538STS	5	.046"/1.17 mm	65 cm	.038" (0.97 mm)
511035STS	5	.046"/1.17 mm	110 cm	.035" (0.89 mm)
511038STS	5	.046"/1.17 mm	110 cm	.038" (0.97 mm)



IMPRESS® OSBORN CATHETERS

Catalog Number	French Size	Internal Diameter	Length	# of Side Ports
410035OSB1	4	.040"/1.02 mm	100 cm	-
510035OSB1	5	.046"/1.17 mm	100 cm	-



OSBORN

IMPRESS® MULTIPURPOSE A1 CATHETERS

Catalog Number	French Size	Internal Diameter	Length	# of Side Ports
410038MPA1	4	.040"/1.02 mm	100 cm	-
412538MPA1	4	.040"/1.02 mm	125 cm	-
56538MPA1	5	.046"/1.17 mm	65 cm	-
510038MPA1	5	.046"/1.17 mm	100 cm	-
512538MPA1	5	.046"/1.17 mm	125 cm	-



MULTI A1

IMPRESS® 30 CM CATHETERS

Catalog Number	French Size	Internal Diameter	Length	# of Side Ports
43035MODCB1	4	.040"/1.02 mm	30 cm	-
43035BER	4	.040"/1.02 mm	30 cm	-
43035KA2	4	.040"/1.02 mm	30 cm	-
43035STR	4	.040"/1.02 mm	30 cm	-
43035RIM	4	.040"/1.02 mm	30 cm	-
4303510PIG-NB	4	.040"/1.02 mm	30 cm	10 non-braided
53035MODCB1	5	.046"/1.17 mm	30 cm	-
53035BER	5	.046"/1.17 mm	30 cm	-
53035KA2	5	.046"/1.17 mm	30 cm	-
53035STR	5	.046"/1.17 mm	30 cm	-
53035RIM	5	.046"/1.17 mm	30 cm	-
5303510PIG-NB	5	.049"/1.25 mm	30 cm	10 non-braided

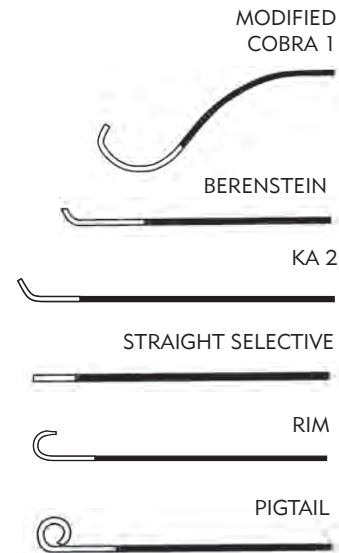

MODIFIED COBRA 1

BERENSTEIN

KA 2

STRAIGHT SELECTIVE

RIM

PIGTAIL

IMPRESS® SHEPHERD FLUSH CATHETERS

Catalog Number	French Size	Internal Diameter	Length	# of Side Ports
465356SHP-NB	4	.040"/1.02 mm	65 cm	6 non-braided
490356SHP-NB	4	.040"/1.02 mm	90 cm	6 non-braided
565356SHP-NB	5	.049"/1.25 mm	65 cm	6 non-braided



SHEPHERD FLUSH

Recommended guide wire is .035" (0.89 mm)

IMPRESS® ULTRA BOLUS FLUSH CATHETERS

Catalog Number	French Size	Internal Diameter	Length	# of Side Ports	Description	Recommended Guide Wire
4653510UBF-NB	4	.040"/1.02 mm	65 cm	10	non-braided	.035" (0.89 mm)
4903510UBF-NB	4	.040"/1.02 mm	90 cm	10	non-braided	.035" (0.89 mm)
5653510UBF-NB	5	.049"/1.25 mm	65 cm	10	non-braided	.035" (0.89 mm)
5903510UBF-NB	5	.049"/1.25 mm	90 cm	10	non-braided	.035" (0.89 mm)



ULTRA BOLUS FLUSH

IMPRESS® MODIFIED BOLUS FLUSH CATHETERS

Catalog Number	French Size	Internal Diameter	Length	# of Side Ports	Description	Recommended Guide Wire
4653810MUBF-NB	4	.040"/1.02 mm	65 cm	10	non-braided	.038" (0.97 mm)
5653810MUBF-NB	5	.049"/1.25 mm	65 cm	10	non-braided	.038" (0.97 mm)



MODIFIED BOLUS FLUSH

IMPRESS® PIGTAIL FLUSH CATHETERS

Catalog Number	French Size	Internal Diameter	Length	# of Side Ports	Description	Recommended Guide Wire
4303510PIG-NB	4	.040"/1.02 mm	30 cm	10	non-braided	.035" (0.89 mm)
4653510PIG-NB	4	.040"/1.02 mm	65 cm	10	non-braided	.035" (0.89 mm)
4903510PIG-NB	4	.040"/1.02 mm	90 cm	10	non-braided	.035" (0.89 mm)
41103510PIG-NB	4	.040"/1.02 mm	110 cm	10	non-braided	.035" (0.89 mm)
5303510PIG-NB	5	.049"/1.25 mm	30 cm	10	non-braided	.035" (0.89 mm)
5653510PIG-NB	5	.049"/1.25 mm	65 cm	10	non-braided	.035" (0.89 mm)
5903510PIG-NB	5	.049"/1.25 mm	90 cm	10	non-braided	.035" (0.89 mm)
51103510PIG-NB	5	.049"/1.25 mm	110 cm	10	non-braided	.035" (0.89 mm)
5653810PIG-NB	5	.049"/1.25 mm	65 cm	10	non-braided	.038" (0.97 mm)
5903810PIG-NB	5	.049"/1.25 mm	90 cm	10	non-braided	.038" (0.97 mm)
51103810PIG-NB	5	.049"/1.25 mm	110 cm	10	non-braided	.038" (0.97 mm)



STRAIGHT

IMPRESS® STRAIGHT FLUSH CATHETERS

Catalog Number	French Size	Internal Diameter	Length	# of Side Ports	Description	Recommended Guide Wire
4653510STF-NB	4	.040"/1.02 mm	65 cm	10	non-braided	.035" (0.89 mm)
4903510STF-NB	4	.040"/1.02 mm	90 cm	10	non-braided	.035" (0.89 mm)
5653510STF-NB	5	.049"/1.25 mm	65 cm	10	non-braided	.035" (0.89 mm)
5903510STF-NB	5	.049"/1.25 mm	90 cm	10	non-braided	.035" (0.89 mm)



PIGTAIL

IMPRESS® MODIFIED HOOK FLUSH CATHETERS

Catalog Number	French Size	Internal Diameter	Length	# of Side Ports	Description	Recommended Guide Wire
465356MHK-NB	4	.040"/1.02 mm	65 cm	6	non-braided	.035" (0.89 mm)
490356MHK-NB	4	.040"/1.02 mm	90 cm	6	non-braided	.035" (0.89 mm)



MODIFIED HOOK FLUSH

IMPRESS® HYDROPHILIC DIAGNOSTIC PERIPHERAL CATHETERS

The Impress hydrophilic catheters feature a hydrophilic coating designed to reduce friction for smoother navigation through tortuous anatomy. The hydrophilic coating is resistant to abrasion and is designed to maintain lubricity throughout the procedure. The tips are tapered to minimise vessel trauma, the accordion hubs are designed to minimise kinking, and the stainless steel braided shaft construction provides maximum flexibility without compromising steerability.

IMPRESS® HYDROPHILIC BENTSON

Catalog Number	French Size	Length	Coating Length
BENTSON 1			
410038B1-H	4	100 cm	40 cm
510038B1-H	5	100 cm	40 cm
BENTSON 2			
410038B2-H	4	100 cm	40 cm
510038B2-H	5	100 cm	40 cm

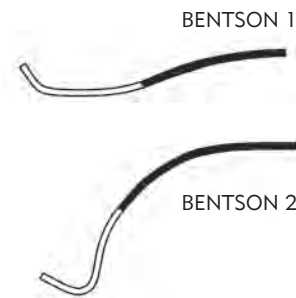

IMPRESS® HYDROPHILIC BERENSTEIN

Catalog Number	French Size	Length	Coating Length
46538BER-H	4	65 cm	25 cm
410038BER-H	4	100 cm	40 cm
412538BER-H	4	125 cm	40 cm
56538BER-H	5	65 cm	25 cm
510038BER-H	5	100 cm	40 cm
512538BER-H	5	125 cm	40 cm



IMPRESS® HYDROPHILIC COBRA

Catalog Number	French Size	Length	Coating Length
COBRA 1			
46538CB1-H	4	65 cm	25 cm
56538CB1-H	5	65 cm	25 cm
COBRA 2			
46538CB2-H	4	65 cm	25 cm
410038CB2-H	4	100 cm	40 cm
56538CB2-H	5	65 cm	25 cm
510038CB2-H	5	100 cm	40 cm

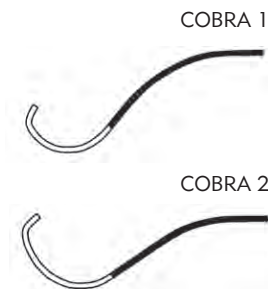

Recommended guide wire is .038" (0.97 mm)

IMPRESS® HYDROPHILIC HEADHUNTER 1

Catalog Number	French Size	Length	Coating Length
410038HH1-H	4	100 cm	40 cm
412538HH1-H	4	125 cm	40 cm
510038HH1-H	5	100 cm	40 cm
512538HH1-H	5	125 cm	40 cm



IMPRESS® HYDROPHILIC KA 2

Catalog Number	French Size	Length	Coating Length
44038KA2-H	4	40 cm	25 cm
46538KA2-H	4	65 cm	25 cm
54038KA2-H	5	40 cm	25 cm
56538KA2-H	5	65 cm	25 cm



IMPRESS® HYDROPHILIC MANI

Catalog Number	French Size	Length	Coating Length
410038MANI-H	4	100 cm	40 cm
510038MANI-H	5	100 cm	40 cm



IMPRESS® HYDROPHILIC MULTIPURPOSE

Catalog Number	French Size	Length	Coating Length
410038MPA1-H	4	100 cm	40 cm
510038MPA1-H	5	100 cm	40 cm

Recommended guide wire is .038" (0.97 mm)



IMPRESS® HYDROPHILIC RBI

Catalog Number	French Size	Length	Coating Length
56538RBI-H	5	65 cm	25 cm



IMPRESS® HYDROPHILIC SIMMONS

Catalog Number	French Size	Length	Coating Length
SIMMONS 1			
410038SIM1-H	4	100 cm	40 cm
510038SIM1-H	5	100 cm	40 cm



SIMMONS 2			
410038SIM2-H	4	100 cm	40 cm
510038SIM2-H	5	100 cm	40 cm



IMPRESS® MODIFIED HOOK HYDROPHILIC

Catalog Number	French Size	Length	Coating Length
MODIFIED HOOK 1			
48038MHK1-H	4	.040"/1.02 mm	80 cm
58038MHK1-H	5	.046"/1.17 mm	80 cm
MODIFIED HOOK 2			
48038MHK2-H	4	.040"/1.02 mm	80 cm
58038MHK2-H	5	.046"/1.17 mm	80 cm
MODIFIED HOOK 3			
48038MHK3-H	4	.040"/1.02 mm	80 cm
58038MHK3-H	5	.046"/1.17 mm	80 cm

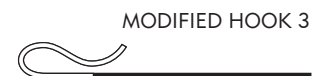

Recommended guide wire is .038" (0.97 mm)

IMPRESS® HYDROPHILIC STRAIGHT SELECTIVE

Catalog Number	French Size	Length	Coating Length
46538STS-H	4	65 cm	25 cm
410038STS-H	4	100 cm	40 cm
412538STS-H	4	125 cm	40 cm
56538STS-H	5	65 cm	25 cm
510038STS-H	5	100 cm	40 cm

STRAIGHT SELECTIVE



IMPRESS® HYDROPHILIC VERTEBRAL

Catalog Number	French Size	Length	Coating Length
46538VER-H	4	65 cm	25 cm
410038VER-H	4	100 cm	40 cm
56538VER-H	5	65 cm	25 cm
510038VER-H	5	100 cm	40 cm

VERTEBRAL







Recommended guide wire is .038" (0.97 mm)

PERFORMA® DIAGNOSTIC PERIPHERAL CATHETERS

Merit Medical's Performa diagnostic peripheral catheters are designed to provide superior torque, increased shaft strength for better pushability, and large inner lumens for improved flow rates.

PERFORMA® HEADHUNTER CATHETERS

ANGIOGRAPHY

Catalog Number	French Size	Internal Diameter	Length	Recommended Guide Wire	Description	
HEADHUNTER 1						
7715-A0	4	.042"/1.07 mm	100 cm	.035" (0.89 mm)		 <p>HEADHUNTER 1</p>
7715-10	4	.042"/1.07 mm	100 cm	.038" (0.97 mm)	bumper tip	
5575-A3	5	.046"/1.17 mm	100 cm	.035" (0.89 mm)		
5575-13	5	.046"/1.17 mm	100 cm	.038" (0.97 mm)		
HEADHUNTER 3						
7715-B0	4	.042"/1.07 mm	100 cm	.035" (0.89 mm)		 <p>HEADHUNTER 3</p>
7715-30	4	.042"/1.07 mm	100 cm	.038" (0.97 mm)	bumper tip	
5575-B3	5	.046"/1.17 mm	100 cm	.035" (0.89 mm)		
5575-23	5	.046"/1.17 mm	100 cm	.038" (0.97 mm)		
HEADHUNTER 5						
7715-C0	4	.042"/1.07 mm	100 cm	.035" (0.89 mm)		 <p>HEADHUNTER 5</p>
7715-50	4	.042"/1.07 mm	100 cm	.038" (0.97 mm)	bumper tip	
5575-C3	5	.046"/1.17 mm	100 cm	.035" (0.89 mm)		
5575-33	5	.046"/1.17 mm	100 cm	.038" (0.97 mm)		
HEADHUNTER 6						
7715-D0	4	.042"/1.07 mm	100 cm	.035" (0.89 mm)		 <p>HEADHUNTER 6</p>
7715-60	4	.042"/1.07 mm	100 cm	.038" (0.97 mm)	bumper tip	
5575-D3	5	.046"/1.17 mm	100 cm	.035" (0.89 mm)		
5575-43	5	.046"/1.17 mm	100 cm	.038" (0.97 mm)		

PERFORMA® NEWTON CATHETERS

Catalog Number	French Size	Internal Diameter	Length	Recommended Guide Wire	Description
NEWTON 1					
7722-A0	4	.042"/1.07 mm	100 cm	.035" (0.89 mm)	
7722-10	4	.042"/1.07 mm	100 cm	.038" (0.97 mm)	bumper tip
5577-A3	5	.046"/1.17 mm	100 cm	.035" (0.89 mm)	
5577-13	5	.046"/1.17 mm	100 cm	.038" (0.97 mm)	
NEWTON 2					
7722-B0	4	.042"/1.07 mm	100 cm	.035" (0.89 mm)	
7722-20	4	.042"/1.07 mm	100 cm	.038" (0.97 mm)	bumper tip
5577-B3	5	.046"/1.17 mm	100 cm	.035" (0.89 mm)	
5577-23	5	.046"/1.17 mm	100 cm	.038" (0.97 mm)	
NEWTON 3					
7722-C0	4	.042"/1.07 mm	100 cm	.035" (0.89 mm)	
7722-30	4	.042"/1.07 mm	100 cm	.038" (0.97 mm)	bumper tip
5577-C3	5	.046"/1.17 mm	100 cm	.035" (0.89 mm)	
5577-33	5	.046"/1.17 mm	100 cm	.038" (0.97 mm)	
NEWTON 4					
7722-D0	4	.042"/1.07 mm	100 cm	.035" (0.89 mm)	
7722-40	4	.042"/1.07 mm	100 cm	.038" (0.97 mm)	bumper tip
5577-D3	5	.046"/1.17 mm	100 cm	.035" (0.89 mm)	
5577-43	5	.046"/1.17 mm	100 cm	.038" (0.97 mm)	
NEWTON 5					
7722-E0	4	.042"/1.07 mm	100 cm	.035" (0.89 mm)	
7722-50	4	.042"/1.07 mm	100 cm	.038" (0.97 mm)	bumper tip
5577-E3	5	.046"/1.17 mm	100 cm	.035" (0.89 mm)	
5577-53	5	.046"/1.17 mm	100 cm	.038" (0.97 mm)	



NEWTON 1



NEWTON 2



NEWTON 3



NEWTON 4



NEWTON 5

PERFORMA® BENTSON CATHETERS

Catalog Number	French Size	Internal Diameter	Length	Recommended Guide Wire	Description
BENTSON 1					
7721-A0	4	.042"/1.07 mm	100 cm	.035" (0.89 mm)	
7721-10	4	.042"/1.07 mm	100 cm	.038" (0.97 mm)	bumper tip
5578-A3	5	.046"/1.17 mm	100 cm	.035" (0.89 mm)	
5578-13	5	.046"/1.17 mm	100 cm	.038" (0.97 mm)	



BENTSON 2					
7721-B0	4	.042"/1.07 mm	100 cm	.035" (0.89 mm)	
7721-20	4	.042"/1.07 mm	100 cm	.038" (0.97 mm)	bumper tip
5578-B3	5	.046"/1.17 mm	100 cm	.035" (0.89 mm)	
5578-23	5	.046"/1.17 mm	100 cm	.038" (0.97 mm)	

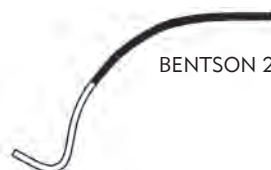

BENTSON 3					
7721-C0	4	.042"/1.07 mm	100 cm	.035" (0.89 mm)	
7721-30	4	.042"/1.07 mm	100 cm	.038" (0.97 mm)	bumper tip
5578-C3	5	.046"/1.17 mm	100 cm	.035" (0.89 mm)	
5578-33	5	.046"/1.17 mm	100 cm	.038" (0.97 mm)	



PERFORMA® MANI CATHETERS

Catalog Number	French Size	Internal Diameter	Length	Recommended Guide Wire	Description
7716-A0	4	.042"/1.07 mm	100 cm	.035" (0.89 mm)	
7716-10	4	.042"/1.07 mm	100 cm	.038" (0.97 mm)	bumper tip
5579-A3	5	.046"/1.17 mm	100 cm	.035" (0.89 mm)	
5579-13	5	.046"/1.17 mm	100 cm	.038" (0.97 mm)	



PERFORMA® VERTEBRAL CATHETERS

Catalog Number	French Size	Internal Diameter	Length	Recommended Guide Wire	Description
7717-A0	4	.042"/1.07 mm	65 cm	.035" (0.89 mm)	
7717-10	4	.042"/1.07 mm	65 cm	.038" (0.97 mm)	bumper tip
7717-C0	4	.042"/1.07 mm	80 cm	.035" (0.89 mm)	
7717-30	4	.042"/1.07 mm	80 cm	.038" (0.97 mm)	bumper tip
7717-B0	4	.042"/1.07 mm	100 cm	.035" (0.89 mm)	
7717-20	4	.042"/1.07 mm	100 cm	.038" (0.97 mm)	bumper tip
5583-B3	5	.046"/1.17 mm	65 cm	.035" (0.89 mm)	
5583-23	5	.046"/1.17 mm	65 cm	.038" (0.97 mm)	
5583-A3	5	.046"/1.17 mm	100 cm	.035" (0.89 mm)	
5583-13	5	.046"/1.17 mm	100 cm	.038" (0.97 mm)	



PERFORMA® MODIFIED CEREBRAL CATHETERS

Catalog Number	French Size	Internal Diameter	Length	Recommended Guide Wire	# of Side Ports	Description
7723-A0	4	.042"/1.07 mm	90 cm	.035" (0.89 mm)	-	
7723-10	4	.042"/1.07 mm	90 cm	.038" (0.97 mm)	-	bumper tip
5588-A3	5	.046"/1.17 mm	100 cm	.035" (0.89 mm)	-	
5588-13	5	.046"/1.17 mm	100 cm	.038" (0.97 mm)	-	

MODIFIED CEREBRAL



PERFORMA® BERENSTEIN CATHETERS

Catalog Number	French Size	Internal Diameter	Length	Recommended Guide Wire	# of Side Ports	Description
7718-C0	4	.042"/1.07 mm	40 cm	.035" (0.89 mm)	-	
7718-30	4	.042"/1.07 mm	40 cm	.038" (0.97 mm)	-	bumper tip
7718-B0	4	.042"/1.07 mm	65 cm	.035" (0.89 mm)	-	
7718-20	4	.042"/1.07 mm	65 cm	.038" (0.97 mm)	-	bumper tip
7718-A0	4	.042"/1.07 mm	100 cm	.035" (0.89 mm)	-	
7718-10	4	.042"/1.07 mm	100 cm	.038" (0.97 mm)	-	bumper tip
5592-C3	5	.046"/1.17 mm	40 cm	.035" (0.89 mm)	-	
5592-33	5	.046"/1.17 mm	40 cm	.038" (0.97 mm)	-	
5592-B3	5	.046"/1.17 mm	65 cm	.035" (0.89 mm)	-	
5592-23	5	.046"/1.17 mm	65 cm	.038" (0.97 mm)	-	
5592-A3	5	.046"/1.17 mm	100 cm	.035" (0.89 mm)	-	
5592-13	5	.046"/1.17 mm	100 cm	.038" (0.97 mm)	-	

BERENSTEIN



PERFORMA® STRAIGHT SELECTIVE CATHETERS

Catalog Number	French Size	Internal Diameter	Length	Recommended Guide Wire	# of Side Ports	Description
7748-A0	4	.042"/1.07 mm	110 cm	.035" (0.89 mm)	-	
7748-13	4	.042"/1.07 mm	110 cm	.038" (0.97 mm)	-	bumper tip

STRAIGHT SELECTIVE



PERFORMA® MW2 CATHETERS

MW2

Catalog Number	French Size	Internal Diameter	Length	Recommended Guide Wire	# of Side Ports	Description
7745-10	4	.042"/1.07 mm	40 cm	.038" (0.97 mm)	2	bumper tip
5590-13	5	.046"/1.17 mm	40 cm	.038" (0.97 mm)	-	
5590-23	5	.046"/1.17 mm	65 cm	.038" (0.97 mm)	-	
5590-33	5	.046"/1.17 mm	100 cm	.038" (0.97 mm)	-	



MW2

MODIFIED MW2

Catalog Number	French Size	Internal Diameter	Length	Recommended Guide Wire	# of Side Ports	Description
7745-A0	4	.042"/1.07 mm	40 cm	.035" (0.89 mm)	2	
7745-B0	4	.042"/1.07 mm	65 cm	.035" (0.89 mm)	2	
7745-C0	4	.042"/1.07 mm	100 cm	.035" (0.89 mm)	2	



MODIFIED MW2

PERFORMA® OSBORN CATHETERS

Catalog Number	French Size	Internal Diameter	Length	Recommended Guide Wire	# of Side Ports	Description
----------------	-------------	-------------------	--------	------------------------	-----------------	-------------

OSBORN 1

7746-A0	4	.042"/1.07 mm	100 cm	.035" (0.89 mm)	-	
7746-10	4	.042"/1.07 mm	100 cm	.038" (0.97 mm)	-	bumper tip



OSBORN 1

OSBORN 2

7746-B0	4	.042"/1.07 mm	65 cm	.035" (0.89 mm)	-	
7746-20	4	.042"/1.07 mm	65 cm	.038" (0.97 mm)	-	bumper tip
7746-C0	4	.042"/1.07 mm	100 cm	.035" (0.89 mm)	-	
7746-30	4	.042"/1.07 mm	100 cm	.038" (0.97 mm)	-	bumper tip



OSBORN 2

PERFORMA® HOOK CATHETERS

Catalog Number	French Size	Internal Diameter	Length	Recommended Guide Wire	# of Side Ports	Description
----------------	-------------	-------------------	--------	------------------------	-----------------	-------------

HOOK 0.8

7711-A0	4	.042"/1.07 mm	65 cm	.035" (0.89 mm)	2	
7711-10	4	.042"/1.07 mm	65 cm	.038" (0.97 mm)	2	bumper tip
5585-A3	5	.046"/1.17 mm	65 cm	.035" (0.89 mm)	2	
5585-13	5	.046"/1.17 mm	65 cm	.038" (0.97 mm)	2	



HOOK 0.8

HOOK 1.0

7711-B0	4	.042"/1.07 mm	65 cm	.035" (0.89 mm)	2	
7711-20	4	.042"/1.07 mm	65 cm	.038" (0.97 mm)	2	bumper tip
5585-B3	5	.046"/1.17 mm	65 cm	.035" (0.89 mm)	2	
5585-23	5	.046"/1.17 mm	65 cm	.038" (0.97 mm)	2	



HOOK 1.0

PERFORMA® MODIFIED HOOK SELECTIVE CATHETERS

Catalog Number	French Size	Internal Diameter	Length	Recommended Guide Wire	# of Side Ports
MODIFIED HOOK 1					
5585-C3	5	.046"/1.17 mm	80 cm	.035" (0.89 mm)	-
MODIFIED HOOK 2					
5585-D3	5	.046"/1.17 mm	80 cm	.035" (0.89 mm)	-
MODIFIED HOOK 3					
5585-E3	5	.046"/1.17 mm	80 cm	.035" (0.89 mm)	-

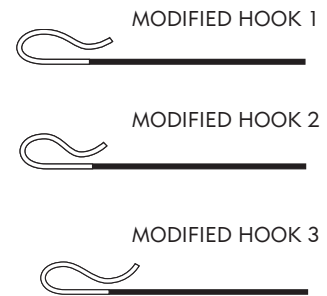

PERFORMA® SIMMONS CATHETERS

Catalog Number	French Size	Internal Diameter	Length	Recommended Guide Wire	Description
SIMMONS 1					
7720-A0	4	.042"/1.07 mm	100 cm	.035" (0.89 mm)	
7720-10	4	.042"/1.07 mm	100 cm	.038" (0.97 mm)	bumper tip
5576-F3	5	.046"/1.17 mm	65 cm	.035" (0.89 mm)	
5576-A3	5	.046"/1.17 mm	100 cm	.035" (0.89 mm)	
5576-13	5	.046"/1.17 mm	100 cm	.038" (0.97 mm)	
SIMMONS 2					
7720-B0	4	.042"/1.07 mm	100 cm	.035" (0.89 mm)	
7720-20	4	.042"/1.07 mm	100 cm	.038" (0.97 mm)	bumper tip
5576-G3	5	.046"/1.17 mm	65 cm	.035" (0.89 mm)	
5576-B3	5	.046"/1.17 mm	100 cm	.035" (0.89 mm)	
5576-23	5	.046"/1.17 mm	100 cm	.038" (0.97 mm)	
SIMMONS 3					
7720-C0	4	.042"/1.07 mm	100 cm	.035" (0.89 mm)	
7720-30	4	.042"/1.07 mm	100 cm	.038" (0.97 mm)	bumper tip
5576-C3	5	.046"/1.17 mm	100 cm	.035" (0.89 mm)	
5576-33	5	.046"/1.17 mm	100 cm	.038" (0.97 mm)	
SIMMONS 4					
7720-D0	4	.042"/1.07 mm	100 cm	.035" (0.89 mm)	
7720-40	4	.042"/1.07 mm	100 cm	.038" (0.97 mm)	bumper tip
5576-D3	5	.046"/1.17 mm	100 cm	.035" (0.89 mm)	
5576-43	5	.046"/1.17 mm	100 cm	.038" (0.97 mm)	
MODIFIED SIMMONS 1.5					
7720-F0	4	.042"/1.07 mm	100 cm	.035" (0.89 mm)	
7720-E0	4	.042"/1.07 mm	80 cm	.035" (0.89 mm)	
7720-70	4	.042"/1.07 mm	110 cm	.038" (0.97 mm)	bumper tip
7720-80	4	.042"/1.07 mm	120 cm	.038" (0.97 mm)	bumper tip
5576-E3	5	.046"/1.17 mm	100 cm	.035" (0.89 mm)	
MODIFIED SIMMONS					
7720-53	4	.042"/1.07 mm	80 cm	.038" (0.97 mm)	bumper tip

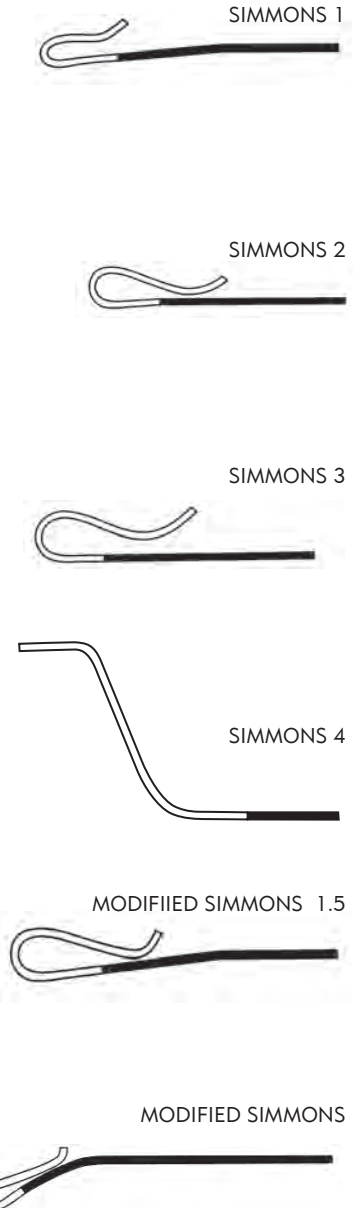

PERFORMA® COBRA CATHETERS

ANGIOGRAPHY

Catalog Number	French Size	Internal Diameter	Length	Recommended Guide Wire	# of Side Ports	Description
----------------	-------------	-------------------	--------	------------------------	-----------------	-------------

COBRA 1

7710-A0	4	.042"/1.07 mm	65 cm	.035" (0.89 mm)	2	
7710-10	4	.042"/1.07 mm	65 cm	.038" (0.97 mm)	2	bumper tip
7710-D0	4	.042"/1.07 mm	65 cm	.035" (0.89 mm)	-	
7710-40	4	.042"/1.07 mm	65 cm	.038" (0.97 mm)	-	bumper tip
5584-A3	5	.046"/1.17 mm	65 cm	.035" (0.89 mm)	2	
5584-D3	5	.046"/1.17 mm	65 cm	.035" (0.89 mm)	-	
5584-13	5	.046"/1.17 mm	65 cm	.038" (0.97 mm)	-	
5584-43	5	.046"/1.17 mm	65 cm	.038" (0.97 mm)	2	



COBRA 2

7710-B0	4	.042"/1.07 mm	65 cm	.035" (0.89 mm)	2	
7710-E0	4	.042"/1.07 mm	65 cm	.035" (0.89 mm)	-	
7710-20	4	.042"/1.07 mm	65 cm	.038" (0.97 mm)	2	bumper tip
7710-50	4	.042"/1.07 mm	65 cm	.038" (0.97 mm)	-	bumper tip
5584-B3	5	.046"/1.17 mm	65 cm	.035" (0.89 mm)	2	
5584-E3	5	.046"/1.17 mm	65 cm	.035" (0.89 mm)	-	
5584-23	5	.046"/1.17 mm	65 cm	.038" (0.97 mm)	-	
5584-53	5	.046"/1.17 mm	65 cm	.038" (0.97 mm)	2	



COBRA 3

7710-C0	4	.042"/1.07 mm	65 cm	.035" (0.89 mm)	2	
7710-F0	4	.042"/1.07 mm	65 cm	.035" (0.89 mm)	-	
7710-30	4	.042"/1.07 mm	65 cm	.038" (0.97 mm)	2	bumper tip
7710-60	4	.042"/1.07 mm	65 cm	.038" (0.97 mm)	-	bumper tip
5584-C3	5	.046"/1.17 mm	65 cm	.035" (0.89 mm)	2	
5584-F3	5	.046"/1.17 mm	65 cm	.035" (0.89 mm)	-	
5584-33	5	.046"/1.17 mm	65 cm	.038" (0.97 mm)	-	
5584-63	5	.046"/1.17 mm	65 cm	.038" (0.97 mm)	2	



PERFORMA® SHEPHERD HOOK CATHETERS

Catalog Number	French Size	Internal Diameter	Length	Recommended Guide Wire	# of Side Ports	Description
----------------	-------------	-------------------	--------	------------------------	-----------------	-------------

SHEPHERD HOOK 0.8

7712-A0	4	.042"/1.07 mm	65 cm	.035" (0.89 mm)	2	
7712-10	4	.042"/1.07 mm	65 cm	.038" (0.97 mm)	2	bumper tip
5586-A3	5	.046"/1.17 mm	65 cm	.035" (0.89 mm)	2	
5586-13	5	.046"/1.17 mm	65 cm	.038" (0.97 mm)	2	

SHEPHERD HOOK 0.8



SHEPHERD HOOK 1.0

7712-B0	4	.042"/1.07 mm	65 cm	.035" (0.89 mm)	2	
7712-20	4	.042"/1.07 mm	65 cm	.038" (0.97 mm)	2	bumper tip
5586-B3	5	.046"/1.17 mm	65 cm	.035" (0.89 mm)	2	
5586-23	5	.046"/1.17 mm	65 cm	.038" (0.97 mm)	2	

SHEPHERD HOOK 1.0



SHEPHERD HOOK 1.0 MODIFIED

7712-C0	4	.042"/1.07 mm	65 cm	.035" (0.89 mm)	2	
7712-D0	4	.042"/1.07 mm	65 cm	.035" (0.89 mm)	-	
7712-30	4	.042"/1.07 mm	65 cm	.038" (0.97 mm)	2	bumper tip
7712-40	4	.042"/1.07 mm	65 cm	.038" (0.97 mm)	-	bumper tip
5586-43	5	.046"/1.17 mm	65 cm	.038" (0.97 mm)	2	

SHEPHERD HOOK 1.0 MOD.



PERFORMA® RENAL DOUBLE CURVE CATHETERS

Catalog Number	French Size	Internal Diameter	Length	Recommended Guide Wire	# of Side Ports	Description
----------------	-------------	-------------------	--------	------------------------	-----------------	-------------

7713-A0	4	.042"/1.07 mm	65 cm	.035" (0.89 mm)	2	
7713-B0	4	.042"/1.07 mm	65 cm	.035" (0.89 mm)	-	
7713-10	4	.042"/1.07 mm	65 cm	.038" (0.97 mm)	2	bumper tip
7713-20	4	.042"/1.07 mm	65 cm	.038" (0.97 mm)	-	bumper tip
5587-A3	5	.046"/1.17 mm	65 cm	.035" (0.89 mm)	2	
5587-13	5	.046"/1.17 mm	65 cm	.038" (0.97 mm)	-	
5587-23	5	.046"/1.17 mm	65 cm	.038" (0.97 mm)	2	

RENAL DOUBLE CURVE



PERFORMA® HOCKEY STICK CATHETERS

Catalog Number	French Size	Internal Diameter	Length	Tip Length	Recommended Guide Wire	# of Side Ports	Description
----------------	-------------	-------------------	--------	------------	------------------------	-----------------	-------------

7752-10	4	.042"/1.07 mm	100 cm	4.5 cm	.038" (0.97 mm)	-	bumper tip
7543-13	5	.046"/1.17 mm	100 cm	4.5 cm	.038" (0.97 mm)	-	
7541-13	6	.054"/1.37 mm	100 cm	4.5 cm	.038" (0.97 mm)	-	

HOCKEY STICK



PERFORMA® AMIR MOTARJEME® CATHETERS

Catalog Number	French Size	Internal Diameter	Length	Recommended Guide Wire	# of Side Ports	Description
----------------	-------------	-------------------	--------	------------------------	-----------------	-------------

AMIR MOTARJEME

7747-C0	4	.042"/1.07 mm	65 cm	.035" (0.89 mm)	-	
7747-D0	4	.042"/1.07 mm	100 cm	.035" (0.89 mm)	-	
7747-E0	4	.042"/1.07 mm	65 cm	.035" (0.89 mm)	2	
7747-F0	4	.042"/1.07 mm	100 cm	.035" (0.89 mm)	2	
5591-A3	5	.046"/1.17 mm	65 cm	.035" (0.89 mm)	-	
5591-B3	5	.046"/1.17 mm	100 cm	.035" (0.89 mm)	-	
5591-C3	5	.046"/1.17 mm	65 cm	.035" (0.89 mm)	2	
5591-D3	5	.046"/1.17 mm	100 cm	.035" (0.89 mm)	2	



MOTARJEME

AMIR MOTARJEME CANE

7747-B0	4	.042"/1.07 mm	65 cm	.035" (0.89 mm)	-	
7747-20	4	.042"/1.07 mm	65 cm	.038" (0.97 mm)	-	bumper tip
7747-A0	4	.042"/1.07 mm	100 cm	.035" (0.89 mm)	-	
7747-10	4	.042"/1.07 mm	100 cm	.038" (0.97 mm)	-	bumper tip
5591-E3	5	.046"/1.17 mm	65 cm	.035" (0.89 mm)	-	
5591-F3	5	.046"/1.17 mm	100 cm	.035" (0.89 mm)	-	



MOTARJEME CANE

PERFORMA® REUTER CATHETERS

Catalog Number	French Size	Internal Diameter	Length	Recommended Guide Wire	# of Side Ports	Description
----------------	-------------	-------------------	--------	------------------------	-----------------	-------------

7714-A0	4	.042"/1.07 mm	80 cm	.035" (0.89 mm)	2	
7714-10	4	.042"/1.07 mm	80 cm	.038" (0.97 mm)	2	bumper tip
7714-B0	4	.042"/1.07 mm	80 cm	.035" (0.89 mm)	-	
7714-20	4	.042"/1.07 mm	80 cm	.038" (0.97 mm)	-	bumper tip
5589-A3	5	.046"/1.17 mm	80 cm	.035" (0.89 mm)	-	
5589-B3	5	.046"/1.17 mm	80 cm	.035" (0.89 mm)	2	
5589-13	5	.046"/1.17 mm	80 cm	.038" (0.97 mm)	-	
5589-23	5	.046"/1.17 mm	80 cm	.038" (0.97 mm)	2	



REUTER

PERFORMA® MIKAELSSON CATHETERS

Catalog Number	French Size	Internal Diameter	Length	Recommended Guide Wire	Description
7719-A0	4	.042"/1.07 mm	80 cm	.035" (0.89 mm)	
7719-10	4	.042"/1.07 mm	80 cm	.038" (0.97 mm)	bumper tip
5594-13	5	.046"/1.17 mm	80 cm	.038" (0.97 mm)	



MIKAELSSON

PERFORMA® KA CATHETERS

Catalog Number	French Size	Internal Diameter	Length	Recommended Guide Wire	Description
5582-23	5	.046"/1.17 mm	65 cm	.038" (0.97 mm)	
5582-33	5	.052"/1.32 mm	65 cm	.038" (0.97 mm)	high flow non-braided



KA

PERFORMA® KA2 CATHETERS

Catalog Number	French Size	Internal Diameter	Length	Recommended Guide Wire
5582-13	5	.046"/1.17 mm	40 cm	.038" (0.97 mm)
5582-43	5	.046"/1.17 mm	65 cm	.038" (0.97 mm)
7514-13	6	.054"/1.37 mm	40 cm	.038" (0.97 mm)
7514-23	6	.054"/1.37 mm	65 cm	.038" (0.97 mm)



KA2

PERFORMA® DVS A1 CATHETERS (10 CM TAPER TIP)

Catalog Number	French Size	Internal Diameter	Length	Recommended Guide Wire
5595-13	5	.046"/1.12 mm	65 cm	.035" (0.89 mm)
5595-33	5	.046"/1.12 mm	100 cm	.035" (0.89 mm)
5595-23	5	.046"/1.12 mm	65 cm	.038" (0.97 mm)
5595-43	5	.046"/1.12 mm	100 cm	.038" (0.97 mm)



DVS A1

PERFORMA® DVS A2 CATHETERS (15 CM TAPER TIP)

Catalog Number	French Size	Internal Diameter	Length	Recommended Guide Wire
5595-A3	5	.046"/1.12 mm	65 cm	.035" (0.89 mm)
5595-C3	5	.046"/1.12 mm	100 cm	.035" (0.89 mm)
5595-B3	5	.046"/1.12 mm	65 cm	.038" (0.97 mm)
5595-D3	5	.046"/1.12 mm	100 cm	.038" (0.97 mm)



DVS A2

PERFORMA® UHF SHEPHERD FLUSH CATHETERS

Catalog Number	French Size	Internal Diameter	Length	Recommended Guide Wire	# of Side Ports	Description
7602-A1	5	.052"/1.32 mm	65 cm	.035" (0.89 mm)	6	non-braided
7602-B1	5	.052"/1.32 mm	90 cm	.035" (0.89 mm)	6	non-braided
7602-C1	5	.052"/1.32 mm	65 cm	.038" (0.97 mm)	6	non-braided
7602-D1	5	.052"/1.32 mm	90 cm	.038" (0.97 mm)	6	non-braided



SHEPHERD FLUSH

PERFORMA® ULTRA BOLUS FLUSH CATHETERS

Catalog Number	French Size	Internal Diameter	Length	Recommended Guide Wire	# of Side Ports	Description
7674-11	5	.052"/1.32 mm	65 cm	.035" (0.89 mm)	10	non-braided
7674-21	5	.052"/1.32 mm	90 cm	.035" (0.89 mm)	10	non-braided
7674-31	5	.052"/1.32 mm	65 cm	.038" (0.97 mm)	10	non-braided
7674-41	5	.052"/1.32 mm	90 cm	.038" (0.97 mm)	10	non-braided



ULTRA BOLUS FLUSH

PERFORMA® ULTRA HIGH FLOW PIGTAIL CATHETERS

Catalog Number	French Size	Internal Diameter	Length	Recommended Guide Wire	# of Side Ports	Description
7602-41	5	.052"/1.32 mm	65 cm	.035" (0.89 mm)	10	non-braided
7602-51	5	.052"/1.32 mm	90 cm	.035" (0.89 mm)	10	non-braided
7602-61	5	.052"/1.32 mm	110 cm	.035" (0.89 mm)	10	non-braided
7602-71	5	.052"/1.32 mm	65 cm	.038" (0.97 mm)	10	non-braided
7602-81	5	.052"/1.32 mm	90 cm	.038" (0.97 mm)	10	non-braided
7602-91	5	.052"/1.32 mm	110 cm	.038" (0.97 mm)	10	non-braided



PIGTAIL

PERFORMA® PIGTAIL FLUSH CATHETER

Catalog Number	French Size	Internal Diameter	Length	Recommended Guide Wire	# of Side Ports	Description
7749-A0	4	.042"/1.07 mm	80 cm	.035" (0.89 mm)	10	braided



PIGTAIL

PERFORMA® STRAIGHT FLUSH CATHETERS

Catalog Number	French Size	Internal Diameter	Length	Recommended Guide Wire	# of Side Ports	Description
7673-11	5	.052"/1.32 mm	65 cm	.035" (0.89 mm)	10	non-braided
7673-21	5	.052"/1.32 mm	90 cm	.035" (0.89 mm)	10	non-braided
7673-31	5	.052"/1.32 mm	65 cm	.035" (0.89 mm)	-	non-braided
7673-41	5	.052"/1.32 mm	65 cm	.038" (0.97 mm)	10	non-braided
7673-51	5	.052"/1.32 mm	90 cm	.038" (0.97 mm)	10	non-braided
7673-61	5	.052"/1.32 mm	65 cm	.038" (0.97 mm)	-	non-braided

STRAIGHT



PERFORMA® MODIFIED HOOK FLUSH CATHETERS

Catalog Number	French Size	Internal Diameter	Length	Recommended Guide Wire	# of Side Ports	Description
7603-A1	5	.052"/1.32 mm	65 cm	.035" (0.89 mm)	6	non-braided
7603-B1	5	.052"/1.32 mm	90 cm	.035" (0.89 mm)	6	non-braided
7603-C1	5	.052"/1.32 mm	65 cm	.038" (0.97 mm)	6	non-braided
7603-D1	5	.052"/1.32 mm	90 cm	.038" (0.97 mm)	6	non-braided

MODIFIED HOOK FLUSH



PERFORMA® VESSEL-SIZING CATHETERS

ALL SIDE PORTS BETWEEN TIP AND FIRST BAND

Vessel-Sizing Catheters (marker catheters) are designed to provide accurate measurement of the patient's anatomy and will take the guesswork out of selecting appropriate interventional devices. Making the correct sizing decisions save time and produce better patient outcomes.

ANGIOGRAPHY

Catalog Number	French Size	Internal Diameter	Length	Recommended Guide Wire	# of side Ports	Bands and Spacing	Description
2 BAND							
7742-2M65SH	4	.041"/1.04 mm	65 cm	.035" (0.89 mm)	5	2 (2 cm apart)	Pigtail
7742-2M100SH	4	.041"/1.04 mm	100 cm	.035" (0.89 mm)	5	2 (2 cm apart)	Pigtail
7744-2M65SH	4	.041"/1.04 mm	65 cm	.035" (0.89 mm)	5	2 (2 cm apart)	Straight
7744-2M100SH	4	.041"/1.04 mm	100 cm	.035" (0.89 mm)	5	2 (2 cm apart)	Straight
7743-2M65SH	4	.041"/1.04 mm	65 cm	.035" (0.89 mm)	5	2 (2 cm apart)	Ultra Bolus
7743-2M100SH	4	.041"/1.04 mm	100 cm	.035" (0.89 mm)	5	2 (2 cm apart)	Ultra Bolus
7755-2M65	4	.041"/1.04 mm	65 cm	.035" (0.89 mm)	6	2 (2 cm apart)	Mod. Hook
7755-2M100	4	.041"/1.04 mm	100 cm	.035" (0.89 mm)	6	2 (2 cm apart)	Mod. Hook
7602-2M65	5	.052"/1.32 mm	65 cm	.035" (0.89 mm)	10	2 (2 cm apart)	Pigtail
7602-2M	5	.052"/1.32 mm	100 cm	.035" (0.89 mm)	10	2 (2 cm apart)	Pigtail
7674-2M65	5	.052"/1.32 mm	65 cm	.035" (0.89 mm)	10	2 (2 cm apart)	Ultra Bolus
7674-2M	5	.052"/1.32 mm	100 cm	.035" (0.89 mm)	10	2 (2 cm apart)	Ultra Bolus
7673-2M65	5	.052"/1.32 mm	65 cm	.035" (0.89 mm)	10	2 (2 cm apart)	Straight
7673-2M	5	.052"/1.32 mm	100 cm	.035" (0.89 mm)	10	2 (2 cm apart)	Straight
7603-2M65	5	.052"/1.32 mm	65 cm	.035" (0.89 mm)	6	2 (2 cm apart)	Mod. Hook
7603-2M100	5	.052"/1.32 mm	100 cm	.035" (0.89 mm)	6	2 (2 cm apart)	Mod. Hook

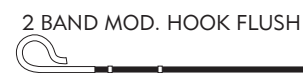

11 BAND

7602-11M65	5	.052"/1.32 mm	65 cm	.035" (0.89 mm)	10	11 (1 cm apart)	Pigtail
7602-11M	5	.052"/1.32 mm	100 cm	.035" (0.89 mm)	10	11 (1 cm apart)	Pigtail
7673-11M65SH	5	.052"/1.32 mm	65 cm	.035" (0.89 mm)	10	11 (1 cm apart)	Straight
7673-11M100SH	5	.052"/1.32 mm	100 cm	.035" (0.89 mm)	10	11 (1 cm apart)	Straight
7603-11M65	5	.052"/1.32 mm	65 cm	.035" (0.89 mm)	6	11 (1 cm apart)	Mod. Hook
7603-11M100	5	.052"/1.32 mm	100 cm	.035" (0.89 mm)	6	11 (1 cm apart)	Mod. Hook



20 BAND

7742-20M65SH	4	.041"/1.04 mm	65 cm	.035" (0.89 mm)	5	20 (1 cm apart)	Pigtail
7742-20M100SH	4	.041"/1.04 mm	100 cm	.035" (0.89 mm)	5	20 (1 cm apart)	Pigtail
7602-20M65	5	.052"/1.32 mm	65 cm	.035" (0.89 mm)	10	20 (1 cm apart)	Pigtail
7602-20M	5	.052"/1.32 mm	100 cm	.035" (0.89 mm)	10	20 (1 cm apart)	Pigtail
7602-20M65SH	5	.052"/1.32 mm	65 cm	.035" (0.89 mm)	5	20 (1 cm apart)	Pigtail
7602-20M100SH	5	.052"/1.32 mm	100 cm	.035" (0.89 mm)	5	20 (1 cm apart)	Pigtail
7673-20M65SH	5	.052"/1.32 mm	65 cm	.035" (0.89 mm)	10	20 (1 cm apart)	Straight
7673-20M100SH	5	.052"/1.32 mm	100 cm	.035" (0.89 mm)	10	20 (1 cm apart)	Straight
7603-20M65SH	5	.052"/1.32 mm	65 cm	.035" (0.89 mm)	6	20 (1 cm apart)	Mod. Hook
7603-20M100SH	5	.052"/1.32 mm	100 cm	.035" (0.89 mm)	6	20 (1 cm apart)	Mod. Hook



SH suffix identifies marker bands that are 16 mm closer to the distal end.

PERFORMA® VESSEL-SIZING CATHETERS

ALL SIDE PORTS BETWEEN BANDS

Catalog Number	French Size	Internal Diameter	Length	# of Side Ports	Bands and Spacing	Description
2 BAND**						
56535AVS2PIG	5	.052"/1.32 mm	65 cm	10	2 (2 cm apart)	Pigtail
510035AVS2PIG	5	.052"/1.32 mm	100 cm	10	2 (2 cm apart)	Pigtail
56535AVS2STR	5	.052"/1.32 mm	65 cm	10	2 (2 cm apart)	Straight
510035AVS2STR	5	.052"/1.32 mm	100 cm	10	2 (2 cm apart)	Straight
56535AVS2MHK	5	.052"/1.32 mm	65 cm	6	2 (2 cm apart)	Mod Hook
510035AVS2MHK	5	.052"/1.32 mm	100 cm	6	2 (2 cm apart)	Mod Hook

2 BAND PIGTAIL

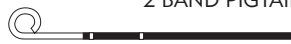

2 BAND STRAIGHT



2 BAND ULTRA BOLUS



2 BAND MOD. HOOK FLUSH

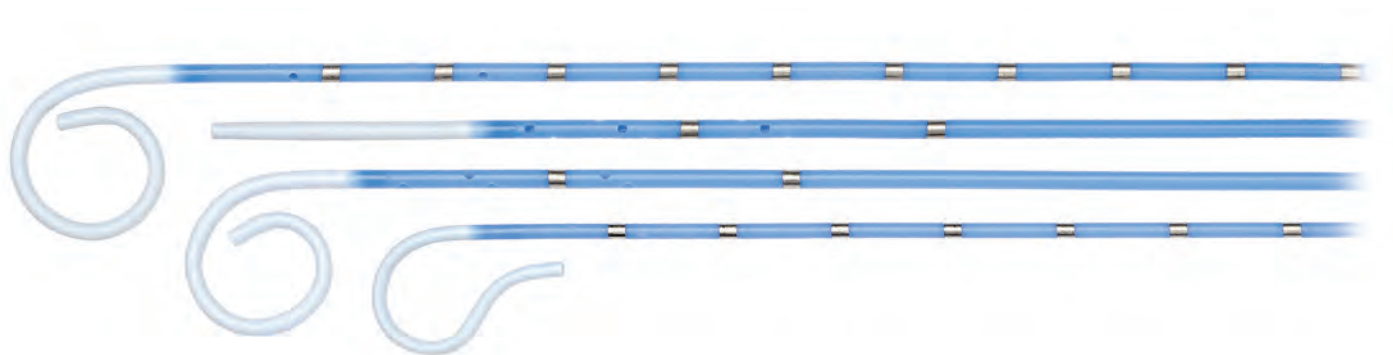

20 BAND**

46535AVS20MHK	4	041"/1.04mm	65 cm	6	20 (1 cm apart)	Mod Hook
56535AVS20PIG	5	.052"/1.32 mm	65 cm	10	20 (1 cm apart)	Pigtail
510035AVS20PIG	5	.052"/1.32 mm	100 cm	10	20 (1 cm apart)	Pigtail
56535AVS20MHK	5	.052"/1.32 mm	65 cm	6	20 (1 cm apart)	Mod Hook
510035AVS20MHK	5	.052"/1.32 mm	100 cm	6	20 (1 cm apart)	Mod Hook

20 BAND PIGTAIL



Recommended guide wire is .035" (0.89 mm)

** Platinum marker bands have side ports placed between bands to allow quick contrast filling of the vessel while visualising the marker bands.

HIGH PRESSURE FLOW CONTROL SWITCH

The Merit Medical High Pressure Flow Control Switch gives you the confidence you need when stopping and starting flow during critical procedures. This feature-rich, integrated, one-handed, single-channel device is designed with clinician and patient safety in mind. Packaged 24 units per box.



Catalog Number U1SHC

CONTRAST TRANSFER (CT) SETS

Merit Medical's line of Contrast Transfer Sets are interchangeable for use with either contrast or saline solutions. The contrast transfer set features a wide base for insertion support when placing into the contrast bottle. Available with a large bore piercing spike and a large wing, swabbable valve. The saline transfer set has a longer, sharper spike tip for easier insertion into IV solution bags and a blue safety stripe for identification.

Catalog Number

TS120

Contrast spike with 20" (50 cm) small bore tubing and HALKEY-ROBERTS® brand swabbable valve. Packaged 50/box, 4 boxes/case.



Catalog Number

TS220

Saline spike with 20" (50 cm) small bore blue stripe tubing and HALKEY-ROBERTS® brand swabbable valve. Packaged 20/box, 4 boxes/case

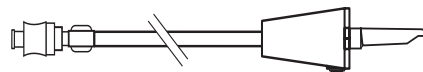

Catalog Number

TS520L

Saline spike with 20" (50 cm) large bore tubing and HALKEY-ROBERTS® brand swabbable valve. Packaged 20/box, 4 boxes/case

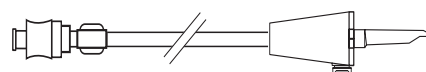

Catalog Number

K08-01961B

Vented, valved spike with 20" (50 cm) small bore tubing and nexus Luer Packaged 25/box, 4 boxes/case.

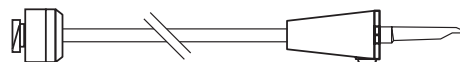

Catalog Number

K08-02195A

Vented, valved spike with 20" (50 cm) small bore blue stripe tubing and nexus Luer Packaged 25/box, 4 boxes/case.

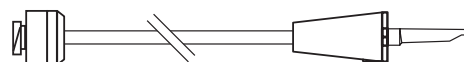

HALKEY-ROBERTS® is a registered trademark of Halkey-Roberts Corporation.

MERIT MAESTRO® MICROCATHETERS

The Merit Maestro is a multipurpose microcatheter designed for use in peripheral and coronary vasculature. It features a hydrophilic coating for smooth traction through tortuous anatomy, a radiopaque marker for easy identification of the distal tip, and an exclusive swan neck design to help seat the catheter in the vessel.

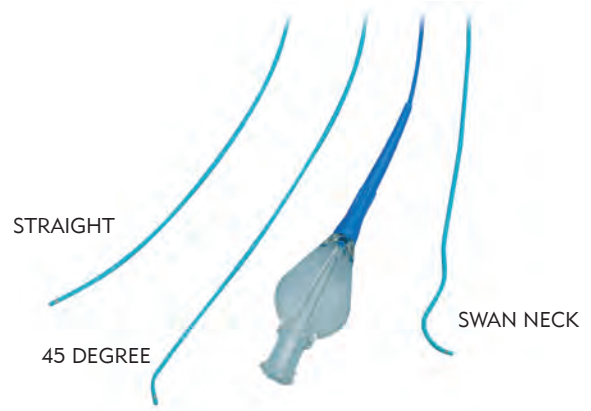

Catalog Number	Proximal	Distal	Length cm	Tip	Minimum Inner Diameter	Recommended Guide Wire	Recommended Guiding Catheter
2.8F TAPERED TO 2.4F							
28MC24110ST	2.8	2.4	110	Straight	.020" (0.52 mm)	.018" (0.46 mm)	.040" (1.02 mm)
28MC24130ST	2.8	2.4	130	Straight	.020" (0.52 mm)	.018" (0.46 mm)	.040" (1.02 mm)
28MC24150ST	2.8	2.4	150	Straight	.020" (0.52 mm)	.018" (0.46 mm)	.040" (1.02 mm)
28MC2411045	2.8	2.4	110	45 degree	.020" (0.52 mm)	.018" (0.46 mm)	.040" (1.02 mm)
28MC2413045	2.8	2.4	130	45 degree	.020" (0.52 mm)	.018" (0.46 mm)	.040" (1.02 mm)
28MC2415045	2.8	2.4	150	45 degree	.020" (0.52 mm)	.018" (0.46 mm)	.040" (1.02 mm)
28MC24110SN	2.8	2.4	110	Swan Neck	.020" (0.52 mm)	.018" (0.46 mm)	.040" (1.02 mm)
28MC24130SN	2.8	2.4	130	Swan Neck	.020" (0.52 mm)	.018" (0.46 mm)	.040" (1.02 mm)
28MC24150SN	2.8	2.4	150	Swan Neck	.020" (0.52 mm)	.018" (0.46 mm)	.040" (1.02 mm)

2.8F NO TAPER

28MC28110ST	2.8	2.8	110	Straight	.024" (0.62 mm)	.021" (0.53 mm)	.040" (1.02 mm)
28MC28130ST	2.8	2.8	130	Straight	.024" (0.62 mm)	.021" (0.53 mm)	.040" (1.02 mm)
28MC28150ST	2.8	2.8	150	Straight	.024" (0.62 mm)	.021" (0.53 mm)	.040" (1.02 mm)
28MC2811045	2.8	2.8	110	45 degree	.024" (0.62 mm)	.021" (0.53 mm)	.040" (1.02 mm)
28MC2813045	2.8	2.8	130	45 degree	.024" (0.62 mm)	.021" (0.53 mm)	.040" (1.02 mm)
28MC2815045	2.8	2.8	150	45 degree	.024" (0.62 mm)	.021" (0.53 mm)	.040" (1.02 mm)
28MC28110SN	2.8	2.8	110	Swan Neck	.024" (0.62 mm)	.021" (0.53 mm)	.040" (1.02 mm)
28MC28130SN	2.8	2.8	130	Swan Neck	.024" (0.62 mm)	.021" (0.53 mm)	.040" (1.02 mm)
28MC28150SN	2.8	2.8	150	Swan Neck	.024" (0.62 mm)	.021" (0.53 mm)	.040" (1.02 mm)

2.9F NO TAPER

29MC29110ST	2.9	2.9	110	Straight	.027" (0.68 mm)	.021" (0.53 mm)	.042" (1.07 mm)
29MC29130ST	2.9	2.9	130	Straight	.027" (0.68 mm)	.021" (0.53 mm)	.042" (1.07 mm)
29MC29150ST	2.9	2.9	150	Straight	.027" (0.68 mm)	.021" (0.53 mm)	.042" (1.07 mm)
29MC2911045	2.9	2.9	110	45 degree	.027" (0.68 mm)	.021" (0.53 mm)	.042" (1.07 mm)
29MC2913045	2.9	2.9	130	45 degree	.027" (0.68 mm)	.021" (0.53 mm)	.042" (1.07 mm)
29MC2915045	2.9	2.9	150	45 degree	.027" (0.68 mm)	.021" (0.53 mm)	.042" (1.07 mm)
29MC29110SN	2.9	2.9	110	Swan Neck	.027" (0.68 mm)	.021" (0.53 mm)	.042" (1.07 mm)
29MC29130SN	2.9	2.9	130	Swan Neck	.027" (0.68 mm)	.021" (0.53 mm)	.042" (1.07 mm)
29MC29150SN	2.9	2.9	150	Swan Neck	.027" (0.68 mm)	.021" (0.53 mm)	.042" (1.07 mm)

All Merit Maestro Microcatheters are rated to 800 psi infusion dynamic pressure. Microcatheters sold individually.

MEDALLION® SYRINGES

Merit Medical's Medallion syringes come in seven colour options with custom printing, or a frosted field for writing information directly on the syringe barrel. The Medallion Syringe features a clear polycarbonate barrel, coloured plunger, and fixed male luer. Packaged 25 units per box, 4 boxes per case.



MSS011-LG

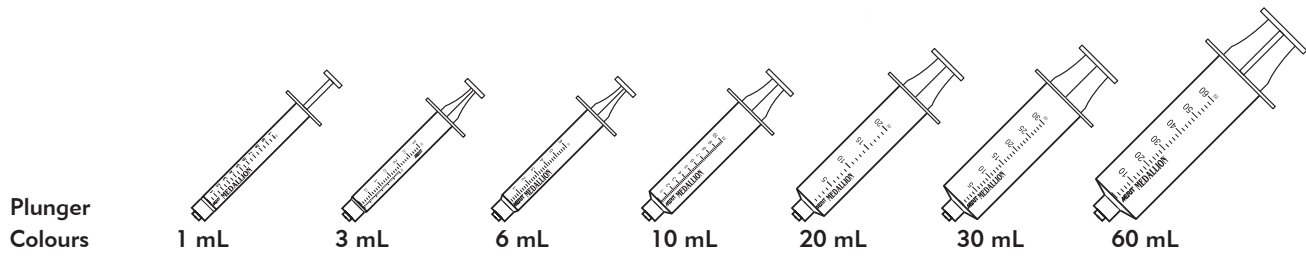

Plunger
Colours

White	MSS011	MSS031	MSS061	MSS111	MSS121	MSS131	MSS160
Light Blue	MSS011-LB	MSS031-LB	MSS061-LB	MSS111-LB	MSS121-LB	MSS131-LB	
Yellow	MSS011-Y	MSS031-Y	MSS061-Y	MSS111-Y	MSS121-Y	MSS131-Y	
Red	MSS011-R	MSS031-R	MSS061-R	MSS111-R	MSS121-R	MSS131-R	
Light Green	MSS011-LG	MSS031-LG	MSS061-LG	MSS111-LG	MSS121-LG	MSS131-LG	
Dark Green	MSS011-DG	MSS031-DG	MSS061-DG	MSS111-DG	MSS121-DG	MSS131-DG	
Purple	MSS011-PR	MSS031-PR	MSS061-PR	MSS111-PR	MSS121-PR	MSS131-PR	

MEDALLION SYRINGES with clear polycarbonate barrel, coloured plunger, black medication printing, and fixed male Luer. Packaged 25 units per box, 4 boxes per case.



Plunger
Colours

	NITRO (10 mL)	LIDOCAINE (10 mL)	HEPARIN (10 mL)	CONTRAST (10 mL)	SALINE (10 mL)
Light Blue	K01-60085	K01-60081	K01-60082	K01-60086	K01-60083
Yellow	K01-60101	K01-60097	K01-60098	K01-60102	K01-60099
Red	K01-60109	K01-60105	K01-60106	K01-60110	
White	K01-60077			K01-60078	K01-60075
Light Green	K01-60093	K01-60089	K01-60090	K01-60094	
Dark Green				K01-00786	

Plunger
Colours

	FENTANYL (3 mL)	XYLOCAINE (10 mL)	VERSED (3 mL)	FLUSH (10 mL)
Light Blue		K01-00917	K01-05185	K01-05093
Red		K01-00953		
Light Green	K01-03243			

NOTE: Catalog numbers in **BOLD TYPE** are available for immediate delivery. Please allow up to eight weeks delivery for others (minimum quantities required).

MEDALLION® SWORD HANDLE SYRINGES

Medallion Sword Handle Syringes feature sword handles, clear polycarbonate plungers, and fixed male luers. Packaged 25 units per box, 4 boxes per case.

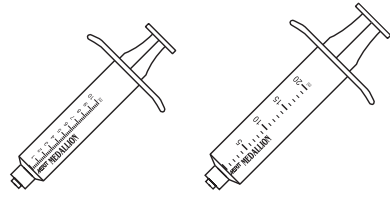

Plunger Colours	10 mL	20 mL
White	MSSW11	MSSW21
Light Blue	MSSW11-LB	MSSW21-LB
Yellow	MSSW11-Y	MSSW21-Y
Red	MSSW11-R	MSSW21-R
Light Green	MSSW11-LG	MSSW21-LG
Dark Green	MSSW11-DG	MSSW21-DG
Purple	MSSW11-PR	MSSW21-PR



MSSW11-Y

ANGIOGRAPHY

MEDALLION® FROSTED FIELD SYRINGES & PEN

The Medallion Frosted Field Syringe allows doctors or clinicians to write additional pertinent information on the barrel. The syringe features a clear polycarbonate barrel, white plunger, white frosted field, and fixed male luer. Packaged 25 units per box, 4 boxes per case.

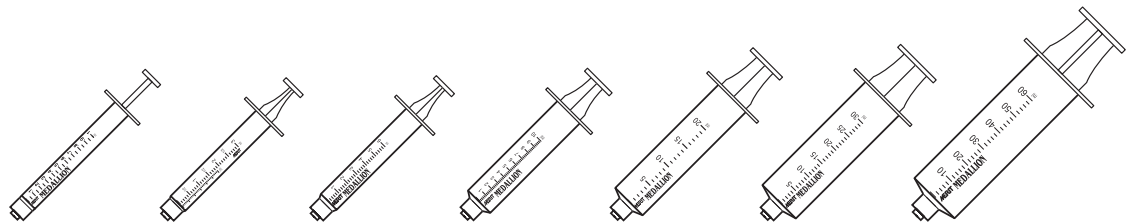

Catalog Number	1 mL	3 mL	6 mL	10 mL	20 mL	30 mL	60 mL
	MSSF011	MSSF031	MSSF061	MSSF111	MSSF121	MSSF131	MSSF160

PEN for labeling Medallion Frosted Field Syringes.



Catalog Number K13-00476

Packaged 25 units per box, 4 boxes per case.

NOTE: Catalog numbers in **BOLD TYPE** are available for immediate delivery. Please allow up to eight weeks delivery for others (minimum quantities required).

CUSTOM MEDALLION® SYRINGES

Merit Medical's signature Medallion Syringes can be custom ordered to your specifications. Medallion Syringes come with a clear polycarbonate barrel, coloured plunger, customised medication printing, and luer options including fixed male or slip luer styles.

Select one option from each category and identify your custom medication to be printed on the barrel. Your Merit Representative will provide you with the corresponding catalog number.

Custom Medallion Syringes are packaged 25 units per box, 4 boxes per case.

ANGIOGRAPHY

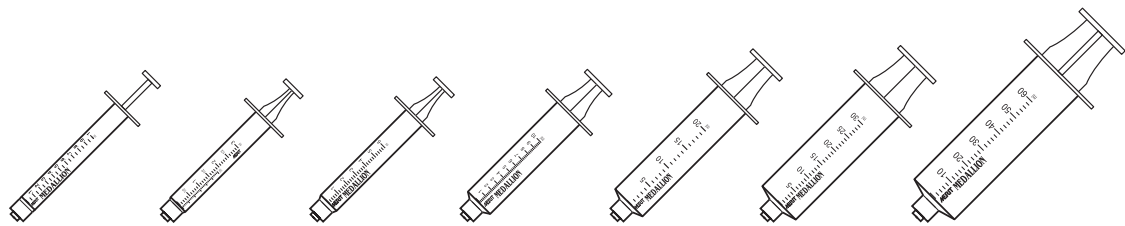
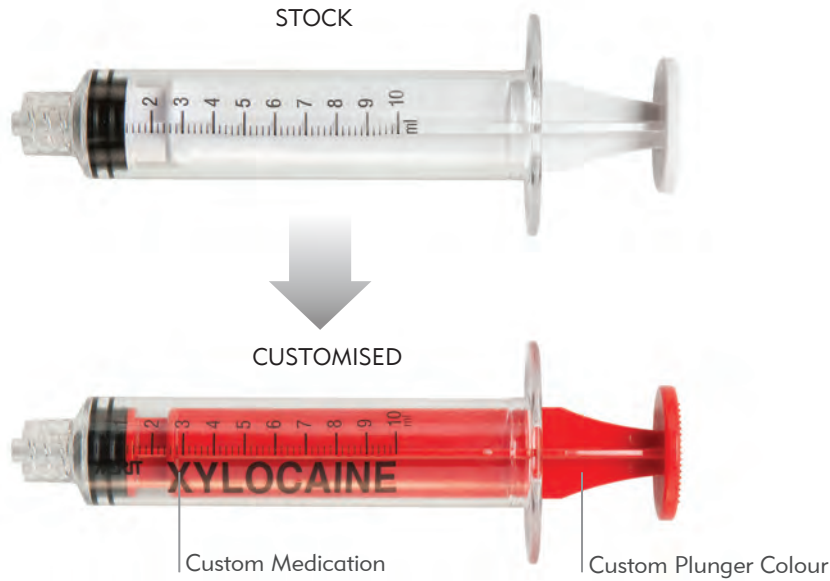

SIZE

OPTIONS

1 mL

3 mL

6 mL

10 mL

20 mL

30 mL

60 mL

PLUNGER COLOUR OPTIONS:

White
Light Blue
Light Green
Dark Green
Yellow
Red
Purple

PRINT COLOUR OPTIONS:

Black
White

LUER OPTIONS:

Fixed Male Luer
Slip Luer

VACLOK® NEGATIVE PREPARATION SYRINGES

The VacLok negative preparation syringe comes with a clear polycarbonate barrel, white plunger, four or six position locking mechanism and fixed male luer. Packaged 20 or 25 units per box, 4 boxes per case.



10 mL
four position
25/box

20 mL
four position
20/box

30 mL
six position
20/box

60 mL
six position
25/box

Catalog Number	K01-07736	K01-07738	K01-07739	K01-07740
----------------	-----------	-----------	-----------	-----------

INTERVENTION

INTERVENTION

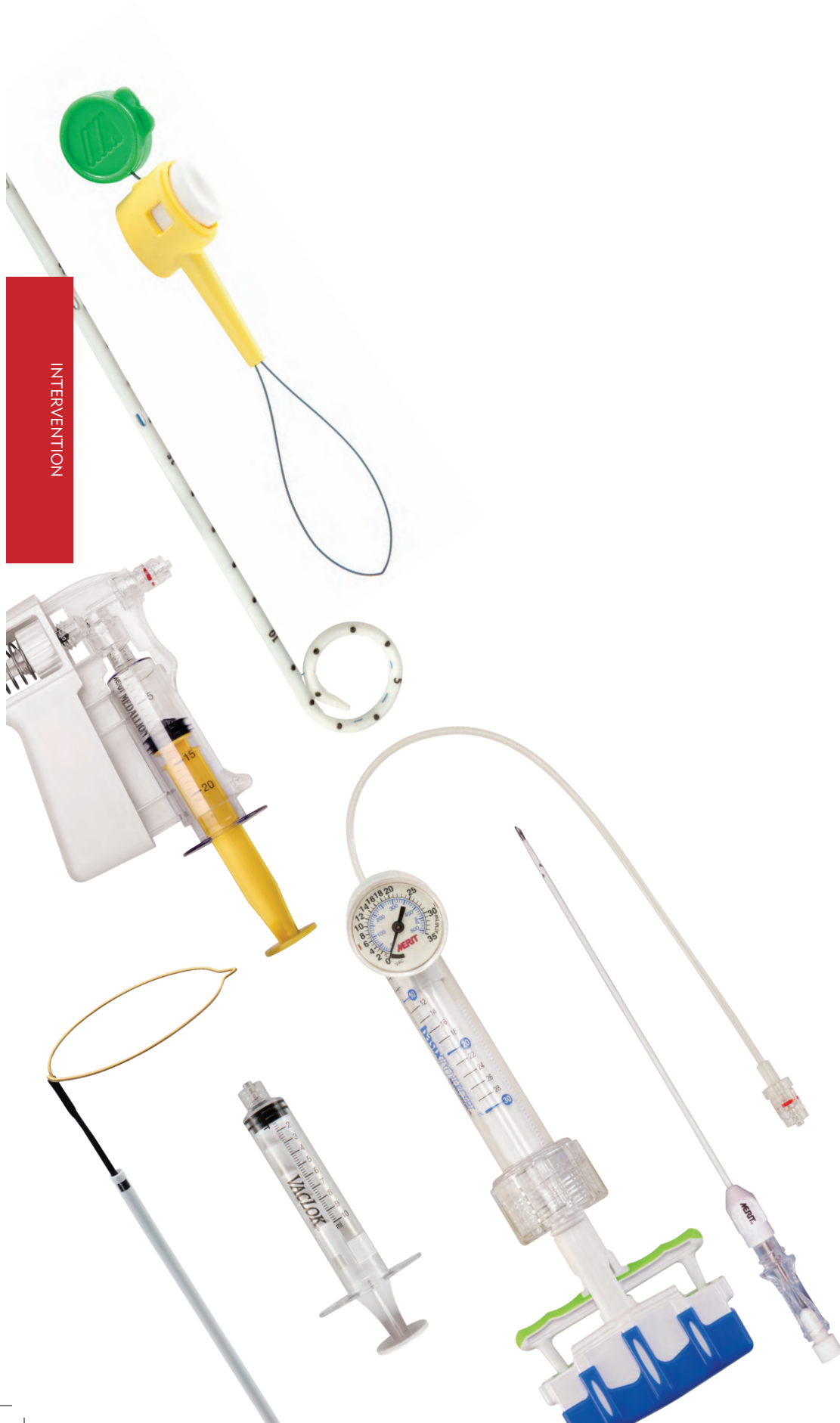

DRAINAGE CATHETERS & ACCESSORIES

MAK-NV™ Introducer System	59
Valve Adapter for MAK-NV	59
ReSolve® Biliary Locking Drainage Catheters	60
Repositioning Tool for Locking Catheters	60
ReSolve Locking Drainage Catheters	61
ReSolve+™ Locking Drainage Catheters	62
Resolve Locking Drainage Catheter Trays	63
ReSolve Non-Locking Drainage Catheters	64
One-Step™ Centesis Catheter	65
Safety Paracentesis Procedure Tray	66
Thoracentesis and Paracentesis Set	67

CATHETER ACCESSORIES

Revolution™ Catheter Securement Device	68
StayFix® Fixation Device	68

DRAINAGE ACCESSORIES

Merit Drainage Depot™ Drainage Bags	69
Abscess Drainage Kit	69
Drainage Kits	69
VacLok® Vacuum Pressure Syringes	70
Marquis® Series Stopcocks	71
Drainage Tubing	71
Connecting Tubes	71

SUPPORT CATHETERS

Merit SureCross™ Support Catheters	72
------------------------------------	----

INFLATION DEVICES

BasixCOMPAK™ Inflation Device	73
BasixTOUCH™ Inflation Device	73
BIG60™ Inflation Device	74
Blue Diamond™ Inflation Device	74

SNARES & ACCESSORIES

EN Snare®	75
ONE Snare®	76
FLO 30™ Tuohy Borst Valved Adapter	76

LONG-TERM HAEMODIALYSIS & PERITONEAL DIALYSIS CATHETERS & ACCESSORIES

Merit Advance® Curved Needles	77
Prelude® Short Sheath Introducers	78
Impress® 30 cm Catheters	79
Centros® & CentrosFLO® Catheters	80
ProGuide™ Chronic Dialysis Catheters	81
ProGuide Basic Kits	81
ProGuide Complete Kits	82
ProGuide Complete Kits with Mini Access Kit	82
OuTake® Catheter Extraction Tool	83
Peritoneal Dialysis Catheters	83
Peritoneal Dialysis Accessories & Implantation Systems	84
Slip-Not® Suture Retention Device	85

THERAPEUTIC INFUSION SYSTEMS

4 French Fountain® Infusion Systems	86
5 French Fountain Infusion Systems	87
Fountain Infusion Catheters	88
Fountain Occluding Wires	89
Squirt® Fluid Dispensing System	89
Pulse Infusion Kits	89-90
Mistique® Infusion Catheters	90

MAK-NV™ (MINI ACCESS KIT, NON-VASCULAR) INTRODUCER SYSTEMS

The MAK-NV introducer system is designed for easy visualisation and quick access into the drainage area. For enhanced visibility, the device features an echo-enhanced needle and radiopaque marker tip on the introducer. Excellent transitions decrease buckling for a smooth insertion. Packaged 5 or 10 units per box.



Coaxial Introducer with Dilator and Stiffening Cannula

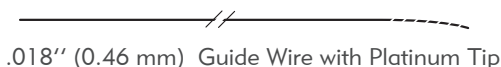

.018" (0.46 mm) Guide Wire with Platinum Tip

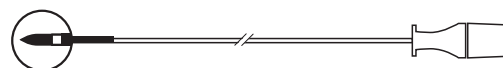

Introducer Needle with Trocar Stylette



Introducer Needle with Chiba Stylette



0.038" (0.97 mm) 3 mm J Guide Wire Heavy Duty Double Ended

Catalog Number	Introducer	Dilator	0.038" (0.97 Mm) 3 mm J Guide Wire		Needle
			0.018" (0.46 Mm) X 60 cm Guide Wire	Heavy Duty Double Ended	
MAK-NV-001	6F x 20 cm	4F	SS/PT	150 cm	21G x 15 cm Trocar
MAK-NV-002	6F x 20 cm	4F	NT/PT	150 cm	21G x 15 cm Trocar
MAK-NV-003	6F x 20 cm	4F	SS/PT	-	21G x 15 cm Trocar
MAK-NV-004	6F x 20 cm	4F	NT/PT	-	21G x 15 cm Trocar
MAK-NV-005*	-	-	-	-	21G x 15 cm Trocar
MAK-NV-006*	6F x 20 cm	4F	-	-	21G x 15 cm Trocar
MAK-NV-007*	6F x 20 cm	4F	-	-	-
MAK-NV-008	6F x 20 cm	4F	SS/PT	80 cm	21G x 15 cm Trocar
MAK-NV-009	6F x 20 cm	4F	NT/PT	80 cm	21G x 15 cm Trocar
MAK-NV-010	6F x 20 cm	4F	SS/PT	150 cm	21G x 15 cm Chiba
MAK-NV-011	6F x 20 cm	4F	NT/PT	150 cm	21G x 15 cm Chiba
MAK-NV-012	6F x 20 cm	4F	SS/PT	-	21G x 15 cm Chiba
MAK-NV-013	6F x 20 cm	4F	NT/PT	-	21G x 15 cm Chiba
MAK-NV-014*	-	-	-	-	21G x 15 cm Chiba
MAK-NV-015*	6F x 20 cm	4F	-	-	21G x 15 cm Chiba
MAK-NV-016	6F x 20 cm	4F	SS/PT	80 cm	21G x 15 cm Chiba
MAK-NV-017	6F x 20 cm	4F	NT/PT	80 cm	21G x 15 cm Chiba
MAK-NV-018	6F x 20 cm	4F	SS/PT	150 cm	21G x 20 cm Trocar
MAK-NV-019	6F x 20 cm	4F	NT/PT	150 cm	21G x 20 cm Trocar
MAK-NV-020*	-	-	-	-	21G x 20 cm Trocar
MAK-NV-021*	-	-	-	-	21G x 20 cm Chiba

SS = Stainless Steel PT = Platinum Tip NT = Nitinol

Packaged 10 per box.

*Packaged 5 per box.

VALVE ADAPTER FOR MAK-NV™ INTRODUCER SYSTEM

Designed to be back-loaded over a guide wire and attached to the MAK-NV Introducer System to facilitate aspiration or infusion. Will accept devices up to 4F. Packaged 10 per box.

Catalog Number VA-40

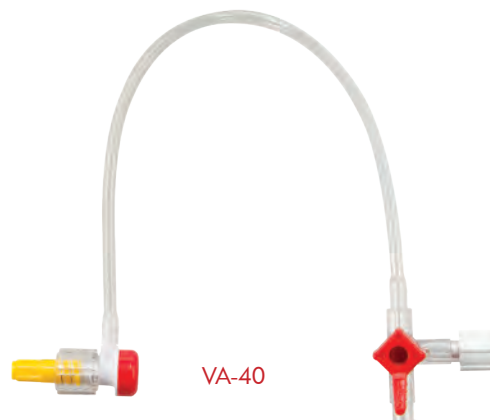

VA-40

RESOLVE® BILIARY LOCKING DRAINAGE CATHETER

The Resolve® Biliary Catheter's polyurethane material allows for long-term indwelling time; large drainage holes help maximise unimpeded drainage. Depth markers and radiopaque marker band help with fast and accurate positioning. Pigtail straightener allows for easy insertion of the stiffening cannulas. Hydrophilic coating facilitates smooth insertion. Packaged 5 per box.

Catalog Number	French Size	Drainage Location	Pigtail to Distal Shaft Drainage Hole	Drainage Holes
RBC-8-038	8.5	14 cm	5 cm	17
RBC-10-038	10	14 cm	5 cm	17
RBC-12-038	12	14 cm	5 cm	18
RBC-14-038	14	14 cm	5 cm	18
RBDC-8-038	8.5	11 cm	2 cm	17
RBDC-10-038	10	11 cm	2 cm	17
RBDC-12-038	12	11 cm	2 cm	18
RBDC-14-038	14	11 cm	2 cm	18

WITH REVOLUTION™ CATHETER SECUREMENT DEVICE

RBC-8-REV	8.5	14 cm	5 cm	17
RBC-10-REV	10	14 cm	5 cm	17
RBC-12-REV	12	14 cm	5 cm	18
RBC-14-REV	14	14 cm	5 cm	18
RBDC-8-REV	8.5	11 cm	2 cm	17
RBDC-10-REV	10	11 cm	2 cm	17
RBDC-12-REV	12	11 cm	2 cm	18
RBDC-14-REV	14	11 cm	2 cm	18

WITH STAYFIX® FIXATION DEVICE

RBC-8-SFX	8.5	14 cm	5 cm	17
RBC-10-SFX	10	14 cm	5 cm	17
RBC-12-SFX	12	14 cm	5 cm	18
RBC-14-SFX	14	14 cm	5 cm	18
RBDC-8-SFX	8.5	11 cm	2 cm	17
RBDC-10-SFX	10	11 cm	2 cm	17
RBDC-12-SFX	12	11 cm	2 cm	18
RBDC-14-SFX	14	11 cm	2 cm	18



REPOSITIONING TOOL

For unlocking ReSolve Locking Drainage Catheters. Packaged 15 per box.

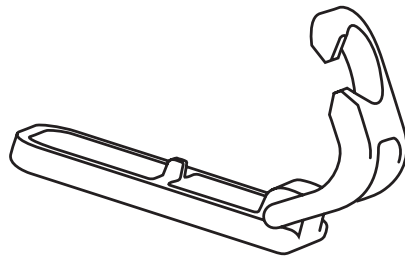

Catalog Number RC-RTOOL

RESOLVE® LOCKING DRAINAGE CATHETERS

The ReResolve Locking Drainage Catheters have a hydrophilic coating and tapered tip for a smooth insertion. Maximum drainage is achieved via the large drainage holes. Features manual release with or without marker band. Packaged individually with catheter, metal and flexible stiffening cannulas, trocar and repositioning tool. Packaged 5 per box.

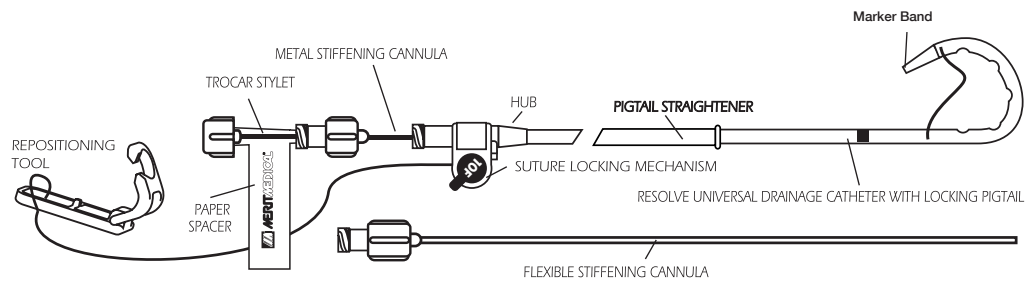

Catalog Number	French Size	Catheter Length	Accepts Guide Wire	Drainage Holes	Marker Band	Tip Configuration
RLC-6-038	6.5	25 cm	0.038" (0.97 mm)	8	-	pigtail
RLC-7-038	7.5	25 cm	0.038" (0.97 mm)	8	-	pigtail
RLC-8-038	8.5	25 cm	0.038" (0.97 mm)	8	-	pigtail
RLC-10-038	10	25 cm	0.038" (0.97 mm)	8	-	pigtail
RLC-12-038	12	25 cm	0.038" (0.97 mm)	8	-	pigtail
RLC-14-038	14	25 cm	0.038" (0.97 mm)	9	-	pigtail
RLC15-6-038MB	6.5	15 cm	0.038" (0.97 mm)	8	yes	pigtail
RLC15-7-038MB	7.5	15 cm	0.038" (0.97 mm)	8	yes	pigtail
RLC15-8-038MB	8.5	15 cm	0.038" (0.97 mm)	8	yes	pigtail
RLC15-10-038MB	10	15 cm	0.038" (0.97 mm)	8	yes	pigtail
RLC15-12-038MB	12	15 cm	0.038" (0.97 mm)	8	yes	pigtail
RLC15-14-038MB	14	15 cm	0.038" (0.97 mm)	9	yes	pigtail
RLC-6-038MB	6.5	25 cm	0.038" (0.97 mm)	8	yes	pigtail
RLC-7-038MB	7.5	25 cm	0.038" (0.97 mm)	8	yes	pigtail
RLC-8-038MB	8.5	25 cm	0.038" (0.97 mm)	8	yes	pigtail
RLC-10-038MB	10	25 cm	0.038" (0.97 mm)	8	yes	pigtail
RLC-12-038MB	12	25 cm	0.038" (0.97 mm)	8	yes	pigtail
RLC-14-038MB	14	25 cm	0.038" (0.97 mm)	9	yes	pigtail
RLC40-6-038MB	6.5	40 cm	0.038" (0.97 mm)	8	yes	pigtail
RLC40-7-038MB	7.5	40 cm	0.038" (0.97 mm)	8	yes	pigtail
RLC40-8-038MB	8.5	40 cm	0.038" (0.97 mm)	8	yes	pigtail
RLC40-10-038MB	10	40 cm	0.038" (0.97 mm)	8	yes	pigtail
RLC40-12-038MB	12	40 cm	0.038" (0.97 mm)	8	yes	pigtail
RLC40-14-038MB	14	40 cm	0.038" (0.97 mm)	9	yes	pigtail



RESOLVE+™ LOCKING DRAINAGE CATHETERS

The ReSolve+ Locking Drainage Catheter provides the convenience of having the ReSolve Locking Drainage Catheter packaged with either the Revolution™ or StayFIX® catheter fixation devices. Packaged 5 per box.

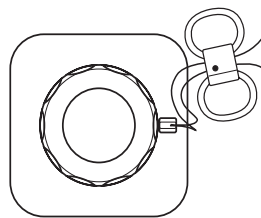
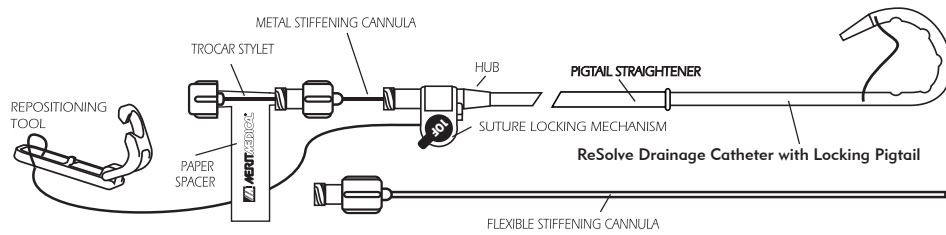

REVOLUTION

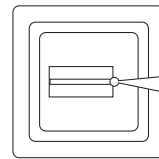

STAYFIX

Small

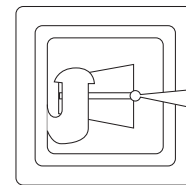

Large

Catalog Number	French Size	Marker Band	Securement Device
RLC-6-REV	6.5	no	Revolution
RLCMB-6-REV	6.5	yes	Revolution
RLC-7-REV	7.5	no	Revolution
RLCMB-7-REV	7.5	yes	Revolution
RLC-8-REV	8.5	no	Revolution
RLCMB-8-REV	8.5	yes	Revolution
RLC-10-REV	10	no	Revolution
RLCMB-10-REV	10	yes	Revolution
RLC-12-REV	12	no	Revolution
RLCMB-12-REV	12	yes	Revolution
RLC-14-REV	14	no	Revolution
RLCMB-14-REV	14	yes	Revolution
RLC-6-SFX	6.5	no	StayFIX (small)
RLCMB-6-SFX	6.5	yes	StayFIX (small)
RLC-7-SFX	7.5	no	StayFIX (small)
RLCMB-7-SFX	7.5	yes	StayFIX (small)
RLC-8-SFX	8.5	no	StayFIX (small)
RLCMB-8-SFX	8.5	yes	StayFIX (small)
RLC-10-SFX	10	no	StayFIX (small)
RLCMB-10-SFX	10	yes	StayFIX (small)
RLC-12-SFX	12	no	StayFIX (small)
RLCMB-12-SFX	12	yes	StayFIX (small)
RLC-14-SFX	14	no	StayFIX (large)
RLCMB-14-SFX	14	yes	StayFIX (large)

RESOLVE® LOCKING DRAINAGE CATHETER TRAYS

The trays conveniently contain the ReResolve Locking Drainage Catheter, MAK-NV™ introducer system, Merit Drainage Depot™ drainage bag, and dilators.

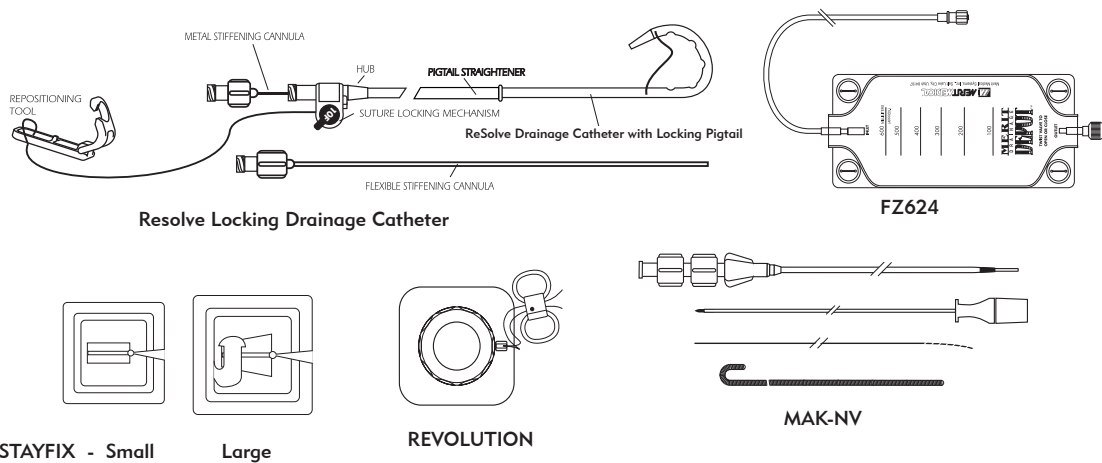

INTERVENTION

Catalog Number	French Size	20 CM Dilator French Size	Marker Band	Securement Device
RLC-NV-6	6.5F	-	no	-
RLC-NV-7	7.5F	-	no	-
RLC-NV-8	8.5F	8F	no	-
RLC-NV-10	10F	8F, 10F	no	-
RLC-NV-12	12F	8F, 10F, 12F	no	-
RLC-NV-14	14F	8F, 10F, 12F, 14F	no	-
RLCMB-NV-6	6.5F	-	yes	-
RLCMB-NV-7	7.5F	-	yes	-
RLCMB-NV-8	8.5F	8F	yes	-
RLCMB-NV-10	10F	8F, 10F	yes	-
RLCMB-NV-12	12F	8F, 10F, 12F	yes	-
RLCMB-NV-14	14F	8F, 10F, 12F, 14F	yes	-
RLC-NV-6-REV	6.5F	-	no	Revolution
RLC-NV-7-REV	7.5F	-	no	Revolution
RLC-NV-8-REV	8.5F	8F	no	Revolution
RLC-NV-10-REV	10F	8F, 10F	no	Revolution
RLC-NV-12-REV	12F	8F, 10F, 12F	no	Revolution
RLC-NV-14-REV	14F	8F, 10F, 12F, 14F	no	Revolution
RLCMB-NV-6-REV	6.5F	-	yes	Revolution
RLC-NV-7-REV	7.5F	-	no	Revolution
RLCMB-NV-8-REV	8.5F	8F	yes	Revolution
RLCMB-NV-10-REV	10F	8F, 10F	yes	Revolution
RLCMB-NV-12-REV	12F	8F, 10F, 12F	yes	Revolution
RLCMB-NV-14-REV	14F	8F, 10F, 12F, 14F	yes	Revolution
RLC-NV-6-SFX	6.5F	-	no	StayFIX (small)
RLC-NV-7-SFX	7.5F	-	no	StayFIX (small)
RLC-NV-8-SFX	8.5F	8F	no	StayFIX (small)
RLC-NV-10-SFX	10F	8F, 10F	no	StayFIX (small)
RLC-NV-12-SFX	12F	8F, 10F, 12F	no	StayFIX (small)
RLC-NV-14-SFX	14F	8F, 10F, 12F, 14F	no	StayFIX (large)
RLCMB-NV-6-SFX	6.5F	-	yes	StayFIX (small)
RLCMB-NV-7-SFX	7.5F	-	yes	StayFIX (small)
RLCMB-NV-8-SFX	8.5F	8F	yes	StayFIX (small)
RLCMB-NV-10-SFX	10F	8F, 10F	yes	StayFIX (small)
RLCMB-NV-12-SFX	12F	8F, 10F, 12F	yes	StayFIX (small)
RLCMB-NV-14-SFX	14F	8F, 10F, 12F, 14F	yes	StayFIX (large)

NOTE: Catalog numbers in **BOLD TYPE** are available for immediate delivery. Please allow up to 13 weeks delivery for others.

RESOLVE® NON-LOCKING DRAINAGE CATHETERS

For a smooth insertion, ReSolve catheters have a tapered tip and hydrophilic coating. Maximum drainage is achieved via the large drainage holes. Packaged individually with catheter, metal stiffening cannula and trocar. Packaged 5 per box.



Catalog Number	French Size	Catheter Length	Accepts Guide Wire	Drainage Holes	Tip Configuration
RNL-6-038S	6.5	20 cm	0.038" (0.97 mm)	4	straight
RNL-7-038S	7.5	25 cm	0.038" (0.97 mm)	4	straight
RNL-8-038S	8.5	25 cm	0.038" (0.97 mm)	4	straight
RNL-10-038S	10	25 cm	0.038" (0.97 mm)	4	straight
RNL-12-038S	12	25 cm	0.038" (0.97 mm)	5	straight
RNL-6-038J	6.5	20 cm	0.038" (0.97 mm)	4	J curve
RNL-7-038J	7.5	25 cm	0.038" (0.97 mm)	4	J curve
RNL-8-038J	8.5	25 cm	0.038" (0.97 mm)	4	J curve
RNL-10-038J	10	25 cm	0.038" (0.97 mm)	4	J curve
RNL-12-038J	12	25 cm	0.038" (0.97 mm)	5	J curve

ONE-STEP™ CENTESIS CATHETERS

The valved One-Step has been designed to improve the comfort, efficiency, and safety of your aspiration, paracentesis, and thoracentesis procedures. The self-closing valve reduces the risk of pneumothorax and fluid leakage. The low profile, tapered tip and smooth transitions help to decrease resistance and patient discomfort. An echo-enhanced needle ensures more accurate placement and four large drainage holes spiral around the catheter for more effective drainage. Available valved and non-valved.

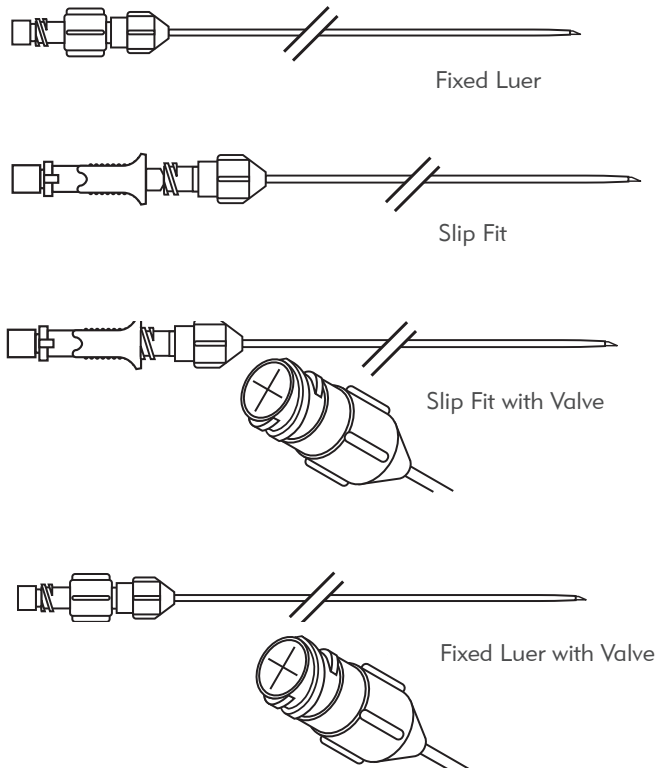

4F WITH 20G INTRODUCER NEEDLE

Catalog Number	4F 7 cm	4F 10 cm	
	OSC-4F-7L	OSC-4F-10L	Fixed Luer
	OSC-4F-7LNH	OSC-4F-10LNH	Fixed Luer no side holes
	OSC-4F-7S	OSC-4F-10S	Slip Fit
	OSC-4F-7T	OSC-4F-10T	Slip Fit with valve
	OSC-4F-7LT	OSC-4F-10LT	Fixed Luer with valve

5F WITH 19G INTRODUCER NEEDLE

Catalog Number	5F 7 cm	5F 10 cm	5F 15 cm	
	OSC-5F-7L	OSC-5F-10L	OSC-5F-15L	Fixed Luer
	OSC-5F-7LNH	OSC-5F-10LNH	OSC-5F-15LNH	Fixed Luer no side holes
	OSC-5F-7S	OSC-5F-10S	OSC-5F-15S	Slip Fit
	OSC-5F-7T	OSC-5F-10T	OSC-5F-15T	Slip Fit with valve
	OSC-5F-7LT	OSC-5F-10LT	OSC-5F-15LT	Fixed Luer with valve

SAFETY PARACENTESIS PROCEDURE TRAY

The Safety Paracentesis Procedure Tray is designed to fulfill clinical needs safely, easily, and in a time-saving way. The tray comes with or without a One-Step centesis catheter, as well as all necessary products to complete a paracentesis procedure and contains three safety needles to ensure a safe working environment.

Quantity Description:

1	One-Step centesis catheter (not included in SPPT-100)
1	Fenestrated Drape with Adhesive Backing
1	Drape Tri Layer (18" x 26")
1	20 mL Lidocaine HCl Injection USP 1%
1	18 G x 1" (25.4 mm) Shielded Needle
1	25 G x 1" (25.4 mm) Shielded Needle
1	22 G x 1.5" (38.1 mm) Shielded Needle
1	10 mL Luer Lock Syringe
10	Gauze Pads 4x4"(10 cm x 10 cm)
1	#11 Futura® Safety Scalpel
1	60 mL Luer Lock Syringe
2	Specimen Vials (10 mL)
1	Non-vented Universal Cap
1	Large Bore Stopcock (3-way)
1	Tubing set, 48" (122 cm) (with Pinch Clamp & Non-vented Spike)
1	Bandage Dressing (1"x3")
1	Kinguard wrap
1	10 mL Medallion® Syringe
1	3 mL ChloraPrep® brand tinted
1	Lidocaine Label



Packaged 5 per box

Catalog Number	Catheter Included	Length	Description
SPPT-100	-	-	without a centesis catheter
SPPT-5F-7L	5F	7 cm	fixed Luer
SPPT-5F-10L	5F	10 cm	fixed Luer
SPPT-5F-7S	5F	7 cm	slip fit
SPPT-5F-10S	5F	10 cm	slip fit

Safety Paracentesis Procedure Trays do not have CE Marking.
ChloraPrep® is a registered trademark of CareFusion 2200, Inc.

THORACENTESIS AND PARACENTESIS SET

The Thoracentesis and Paracentesis Set from Merit Medical combines all the necessary components for centesis procedures in a convenient all-in-one set. Set includes the low-profile valved One-Step centesis catheter and the components needed for drainage of fluid and specimen collection for diagnostic purposes. Merit Medical's valved One-Step centesis catheter is designed with an integrated self-sealing valve to minimise the risk of air entering the pleural space and to prevent fluid leakage during thoracentesis and paracentesis.

Quantity Description:

1	Valved One-Step centesis catheter (not included in TAPS-100)
1	Fenestrated Drape with Adhesive Backing
1	Drape Tri Layer (18" x 26")
1	20 mL Lidocaine HCl Injection USP 1%
1	18 G x 1" (25.4 mm) Shielded Needle
1	25 G x 1" (25.4 mm) Shielded Needle
1	22 G x 1.5" (38.1 mm) Shielded Needle
1	10 mL Luer Lock Syringe
10	Gauze Pads 4x4"(10 cm x 10 cm)
1	#11 Futura® Safety Scalpel
1	60 mL Luer Lock Syringe
2	Specimen Vials (10 mL)
1	Non-vented Female Cap
1	Large Bore Stopcock (3-way)
1	Tubing set, 48" (122 cm) (with Pinch Clamp & Non-vented Spike)
1	Tubing Set, 48" (122 cm) (with Roller Clamp & 16 G X 1.5" needle)
1	Bandage Dressing (1"x 3")
1	CSR wrap
1	10 mL Medallion® Syringe
1	3 mL ChloraPrep® brand tinted Lidocaine Label

Packaged 5 per box

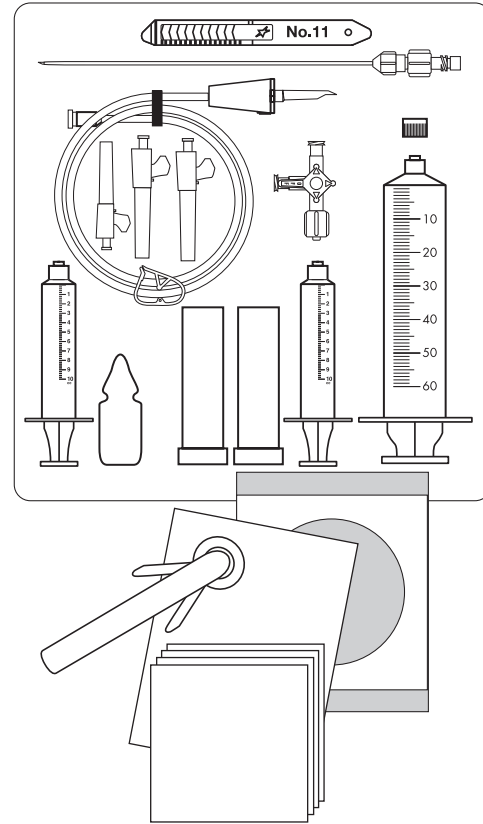

Catalog Number	Catheter Included	Length	Description
TAPS-100	-	-	without a centesis catheter
TAPS-5F-7LT	5	7 cm	fixed Luer
TAPS-5F-10LT	5	10 cm	fixed Luer
TAPS-5F-7T	5	7 cm	slip fit
TAPS-5F-10T	5	10 cm	slip fit

Thoracentesis and Paracentesis Sets do not have CE Marking.
ChloraPrep® is a registered trademark of CareFusion 2200, Inc.

REVOLUTION™ CATHETER SECUREMENT DEVICE

The Revolution catheter securement device provides safe and secure fixation for up to seven days. Its efficient needless design saves time (requires only four steps for securement) and provides an unobstructed view of the catheter site. Includes cap for added protection while showering.

Catalog Number CFG624

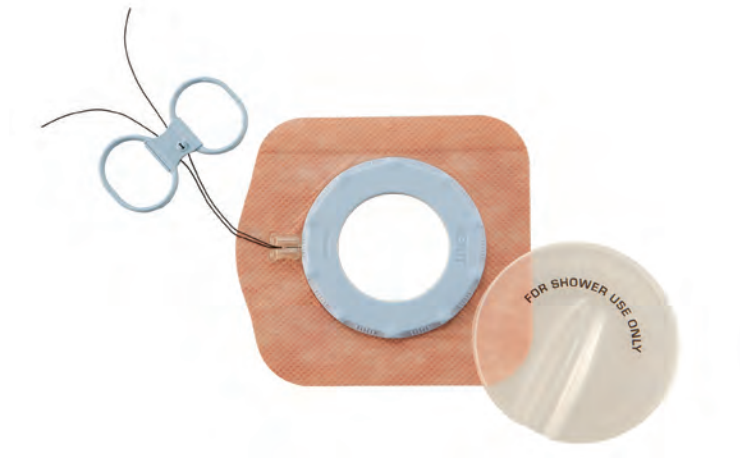

STAYFIX® FIXATION DEVICE

A self-adhesive fastener for percutaneous drainage catheters from 5F - 22F.

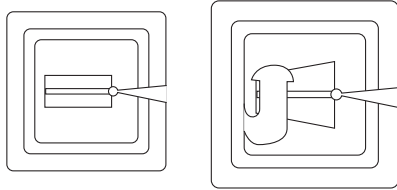

Catalog Number	Product Size	Catheter Or Tube Size	Quantity Per Box
680ME	SMALL	5F - 14F	25
685ME	LARGE	12F - 22F	20

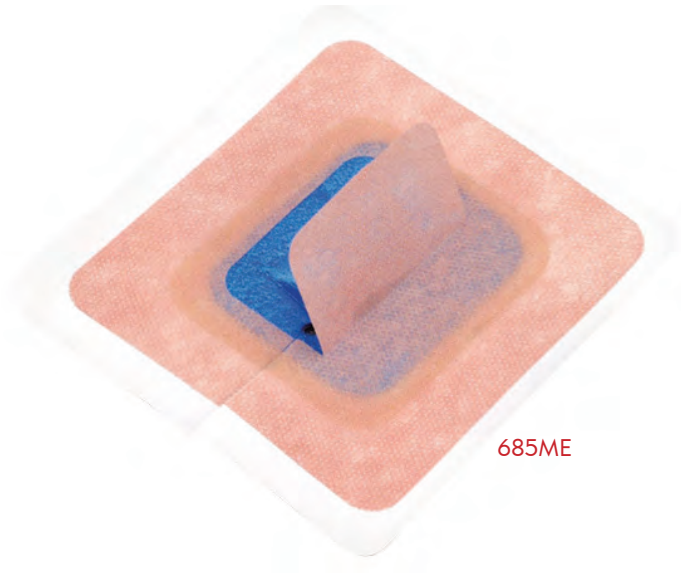

685ME

MERIT DRAINAGE DEPOT™ DRAINAGE BAGS

The Merit Drainage Depot drainage bags have easy-to-read markings to identify fluid volume, a twist valve for easy disposal of fluids, and an internal anti-reflux valve. Available with adjustable length tubing and a VELCRO® brand leg strap to fit a variety of patient sizes. Packaged 20 units per box, 4 boxes per case.

Catalog Number

MDD600	600 mL
FZ624	600 mL - with soft cloth backing



MDD600

ABSCESS DRAINAGE KIT

Packaged 15 units per box, 4 boxes per case.

Catalog Number

K10-00230B

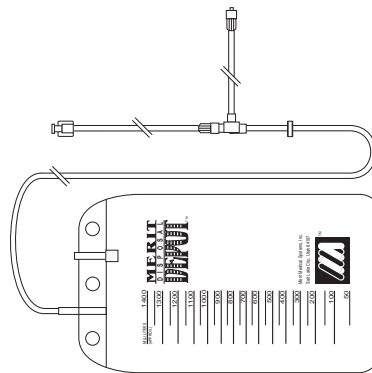

DRAINAGE KITS

16" (41 cm) connection tube with barbed male luer.

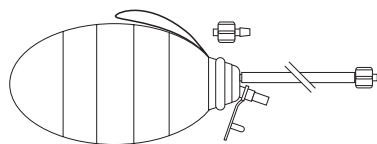

Jackson-Pratt®
100 mL bulb

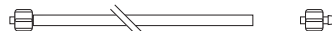

Tubing Kit with
Barbed Male Luer

Catalog Number

K08-01907	Jackson-Pratt® 100 mL Bulb	Packaged 10 units per box, 4 boxes per case
K08-02027	Tubing Kit with Barbed Male Luer	Packaged 25 units per box, 4 boxes per case

DRAINAGE KIT

MDD600 Drainage Bag with Jackson-Pratt 100 mL Bulb, 12" (30.5 cm) connection tube with barbed male luer, 24" (61 cm) kink-resistant tubing, VELCRO® brand fasteners strap and additional barbed male luer connector. Packaged 10 units per box, 4 boxes per case.

Catalog Number K10-03450

Velcro® is a registered trademark of Velcro Industries B.V.
Jackson-Pratt® is a registered trademark of Allegiance Corporation.

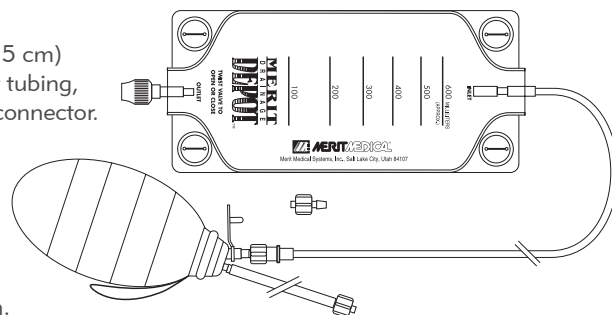

VACLOK® NEGATIVE PREPARATION SYRINGES

The VacLok negative preparation syringe comes with a clear polycarbonate barrel, white plunger, four or six position locking mechanism and fixed male luer. Packaged 20 or 25 units per box, 4 boxes per case.



10 mL
four position
25/box

20 mL
four position
20/box

30 mL
six position
20/box

60 mL
six position
25/box

Catalog Number	K01-07736	K01-07738	K01-07739	K01-07740
----------------	-----------	-----------	-----------	-----------

INTERVENTION

MARQUIS® SERIES STOPCOCK

Merit Medical's larger, easy-grip handle makes a Marquis stopcock effortless to grip and turn. The large bore stopcock with swivel nut luer is available in 50 psi pressure rating. Packaged 50 units per box, 4 boxes per case.

Catalog Number

L3SNC	50 psi	3-way
L4SNC	50 psi	4-way

More stopcock options available in Merit's Cardiac Intervention catalog. Ask for details.



L3SNC

DRAINAGE TUBING

Packaged 25 units per box, 4 boxes per case.

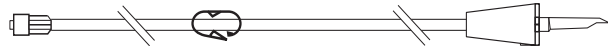

Catalog Number

FAS5248	48" Length (122 cm) Large bore tubing set with non-vented spike
---------	---



FAS5248

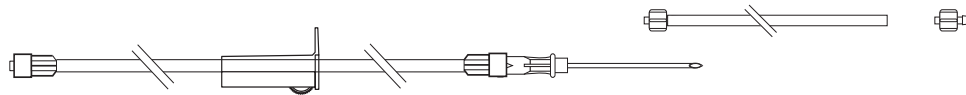

Catalog Number

K10-04750	48" Length (122 cm) Large bore tubing set with 16G x 1.5" (38.1 mm) needle
-----------	--

CONNECTING TUBES

Packaged 25 units per box, 4 boxes per case.

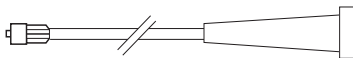

Catalog Number

K10-04129	12" (30 cm)	K10-04131	12" (30 cm) with 1-way stopcock
K10-04130	16.5" (42 cm)	K10-04132	16.5" (42 cm) with 1-way stopcock

MERIT SURECROSS™ SUPPORT CATHETERS

The Merit SureCross support catheter is engineered to optimise pushability and flexibility which maximises guide wire support, trackability, and lesion crossing. The SureCross has a translucent shaft for visualisation of blood to verify placement, 3 platinum marker bands to confirm position, 40 cm distal hydrophilic coating, and comes in multiple lengths.

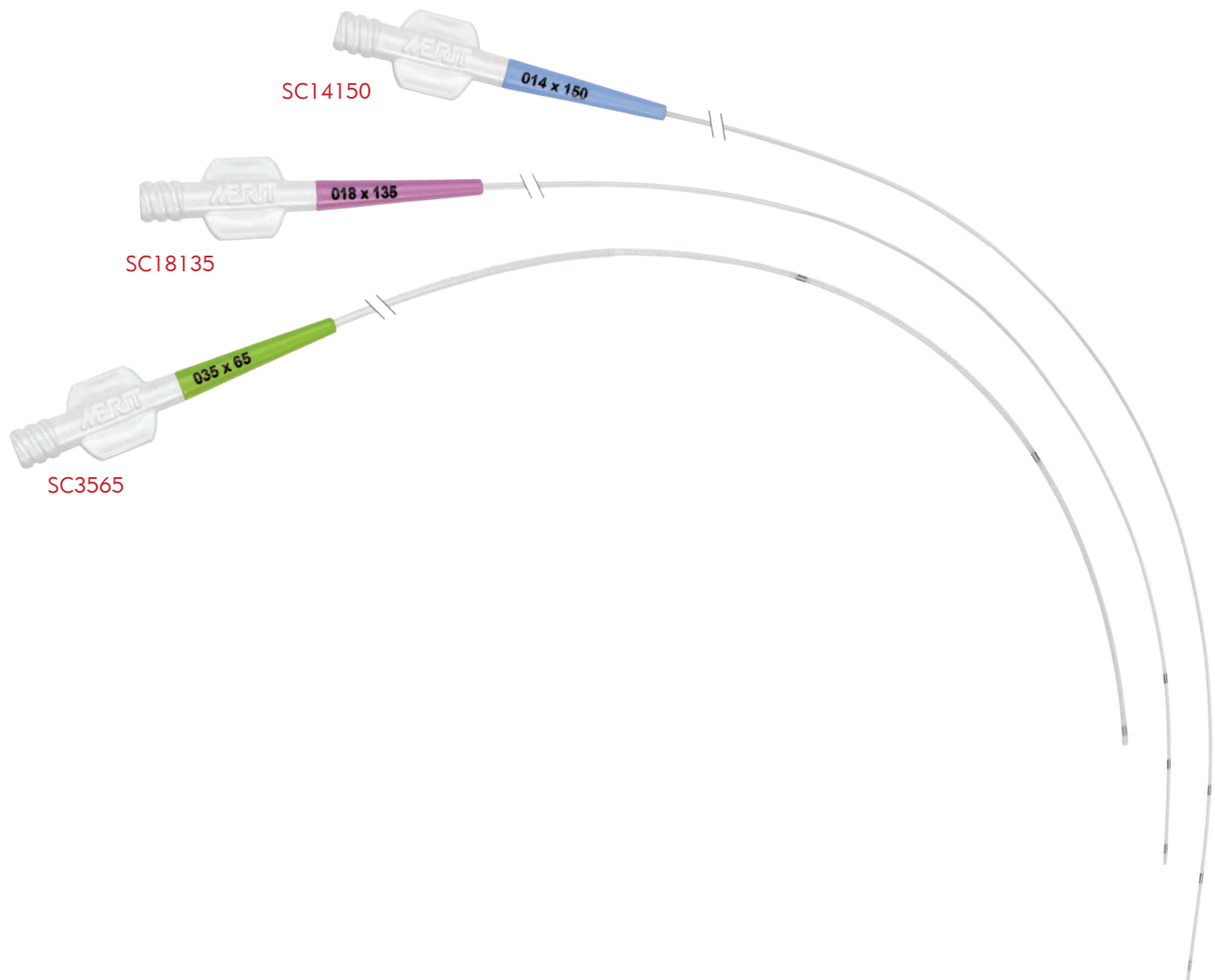

INTERVENTION

Catalog Number	Guide Wire Compatibility	Minimum Guiding Catheter	Minimum Sheath Introducer	Working Length	Number Of Marker Bands	2nd & 3rd Marker Bands Spacing	Hydrophilic Coating Length	Strain Relief Colour
SC1465	0.014"	5F	4F	65 cm	3	15 mm	40 cm	Blue
SC1490	0.014"	5F	4F	90 cm	3	15 mm	40 cm	Blue
SC14135	0.014"	5F	4F	135 cm	3	15 mm	40 cm	Blue
SC14150	0.014"	5F	4F	150 cm	3	15 mm	40 cm	Blue
SC1865	0.018"	5F	4F	65 cm	3	15 mm	40 cm	Purple
SC1890	0.018"	5F	4F	90 cm	3	15 mm	40 cm	Purple
SC18135	0.018"	5F	4F	135 cm	3	15 mm	40 cm	Purple
SC18150	0.018"	5F	4F	150 cm	3	15 mm	40 cm	Purple
SC3565	0.035"	6F	5F	65 cm	3	50 mm	40 cm	Green
SC3590	0.035"	6F	5F	90 cm	3	50 mm	40 cm	Green
SC35135	0.035"	6F	5F	135 cm	3	50 mm	40 cm	Green
SC35150	0.035"	6F	5F	150 cm	3	50 mm	40 cm	Green

BowTie™ Guide Wire Insertion Device included in 0.014" and 0.018" configurations.

BASIXCOMPAK™ INFLATION DEVICE

The BasixCOMPAK is a 30 atm analog inflation device that features an angled gauge for better viewing of pressure readings and a luminescent dial for low-light procedures. The 5 mL of safety space is intended to minimise air bubbles introduced into the balloon. Includes 13" (33 cm) extension tubing and 3-way stopcock. Packaged 5 units per box, 4 boxes per case.

Catalog Number IN4130



BASIXTOUCH™ INFLATION DEVICE

The BasixTOUCH inflation device is an innovative device with an ergonomic handle that enables one-handed preparation and priming, 35 atm pressure capability and 30 mL fluid capacity. Features a quick-release handle for easy release even from high-pressure inflations, accelerating deflation time. Reaches high pressures rapidly - with less than 3 rotations of the handle. Comes with high pressure stopcock. Packaged 5 per box.

Catalog Number IN8130



BIG60® INFLATION DEVICE

The BIG60 inflation device is designed to rapidly inflate and deflate non-vascular balloon dilators while accurately monitoring and displaying crucial inflation pressures. The ergonomically designed 60 mL inflation device is a one-piece, easy-to-use disposable device that pairs Merit Medical's market-leading inflation device experience with our non-vascular stent technology.

Catalog Number ENDO-AN6012



BLUE DIAMOND™ INFLATION DEVICE

The 30 atm Blue Diamond inflation device combines the accuracy of a digital device with the simplicity of analog systems. Features include one-button functionality for simplicity, a large dial face with oversize digits to enhance visibility, and last inflation marks to recall the highest pressure of the previous inflation. Comes with 13" (33 cm) extension tubing and 3-way stopcock. Packaged 5 units per box, 4 boxes per case.

Catalog Number IN7130



EN SNARE® ENDOVASCULAR SNARE SYSTEMS

The EN Snare Endovascular Snare System features three interlaced loops to retrieve and manipulate foreign objects in the body. The EN Snare is designed to rotate and expand for excellent coverage and retrieval within a variety of vessel sizes. Platinum strands are incorporated into the EN Snare loops for excellent visualisation under fluoroscopy.

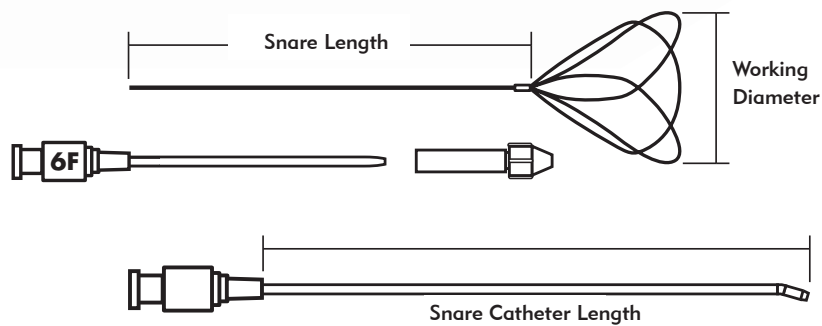
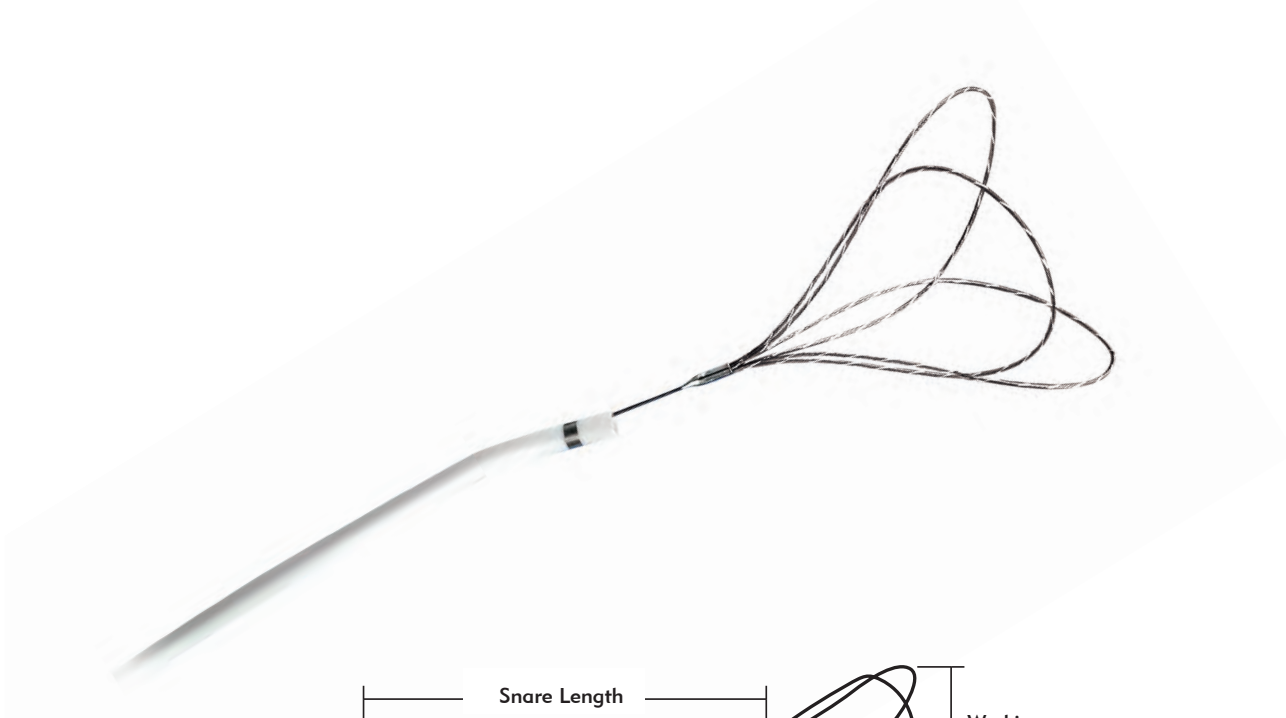

Catalog Number	Snare System Description	Working Diameter (mm)	Snare Length (cm)	Shaft Diameter (in)	Catheter Size (French)	Snare Catheter Length (cm)	Collapsed Snare Diameter	Catheter Inside Diameter
REN1003004	Mini	2-4	175	.018	3.2	150	.028	.030
EN1003008	Mini	4-8	175	.018	3.2	150	.028	.030
EN2006010	Standard	6-10	120	.026	6	100	.045	.062
EN2006015	Standard	9-15	120	.026	6	100	.055	.062
EN2006020	Standard	12-20	120	.026	6	100	.055	.062
EN2007030	Standard	18-30	120	.026	7	100	.055	.074
EN2007045	Standard	27-45	120	.026	7	100	.055	.074

Each EN Snare Endovascular Snare System contains: 1- Snare, 1- Snare Delivery Catheter, 1- Torque Device, 1- Introducer

SNARE Systems SOLD INDIVIDUALLY

ONE SNARE® ENDOVASCULAR SNARE SYSTEMS

The ONE Snare Endovascular Snare System is a single-loop snare designed to provide both accuracy and reliability for effective foreign body manipulation and retrieval. Superelastic Nitinol provides flexibility and kink resistance. Gold-plated tungsten is wrapped around the Nitinol loop for excellent visualisation under fluoroscopy. The ONE Snare is available in multiple configurations to provide retrieval options within a variety of vessel sizes.

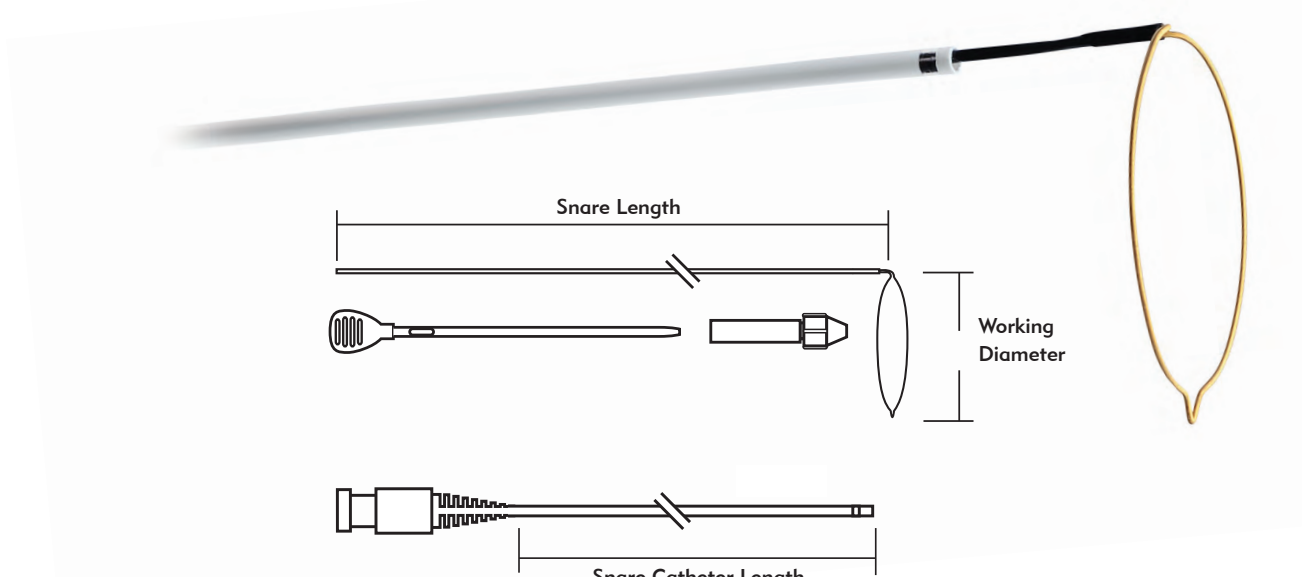

Catalog Number	Snare System Description	Working Diameter (mm)	Snare Length (cm)	Shaft Diameter (in)	Catheter Size (French)	Snare Catheter Length (cm)	Catheter Inside Diameter
ONE500	Standard	5	120	0.032	4	100	0.04
ONE1000	Standard	10	120	0.032	4	100	0.04
ONE1500	Standard	15	120	0.035	6	100	0.056
ONE2000	Standard	20	120	0.035	6	100	0.056
ONE2500	Standard	25	120	0.035	6	100	0.056
ONE3000	Standard	30	120	0.035	6	100	0.056
ONE3500	Standard	35	120	0.035	6	100	0.056
ONE1001	Petite	10	65	0.032	4	48	0.04
ONE2501	Petite	25	65	0.035	6	48	0.056
ONE4000	Catheter	-	-	-	4	100	0.04
ONE6000	Catheter	-	-	-	6	100	0.056

Each ONE Snare Endovascular Snare System contains: 1- Snare, 1- Snare Delivery Catheter, 1- Torque Device, 1- Introducer

SNARE Systems SOLD INDIVIDUALLY

FLO 30™ TUOHY BORST VALVED ADAPTER

Merit Medical's FLO 30 Tuohy Borst is a single-use, proprietary valved adapter which provides a leak-proof seal during interventional and diagnostic procedures.



FLO30P

Catalog Number	Description
FLO30P	FLO 30™ Tuohy Borst French Size: 9F

MERIT ADVANCE® CURVED NEEDLES

The Merit Advance Curved needle is used to aid clinicians who want to place a tunneled dialysis catheter over a wire with a single stick.

Catalog Number	Wall Gauge	Thickness	Accepts Wire	Length (cm)	Length (Inch)	Finish
AD21T91R	21	THIN	.021	9	3.5	Smooth
AD21T91RE	21	THIN	.021	9	3.5	Echo

Packaged 10 per box, 4 boxes per case.

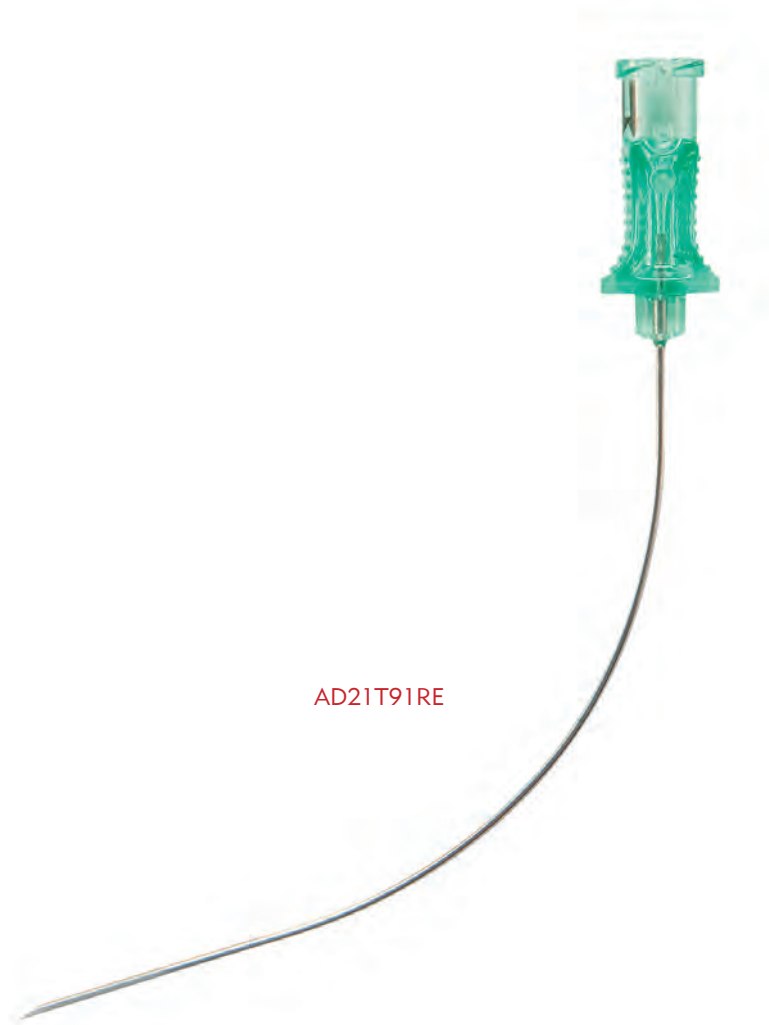

AD21T91RE

PRELUDE® SHORT SHEATH INTRODUCERS

The Prelude Short Sheath Introducer provides access to dialysis fistulas and grafts. Can be used for declot, angioplasty, and thrombolysis procedures, as well as temporary haemodialysis. Will accommodate flow rates up to 600 mL/min. Includes removable stopcock.

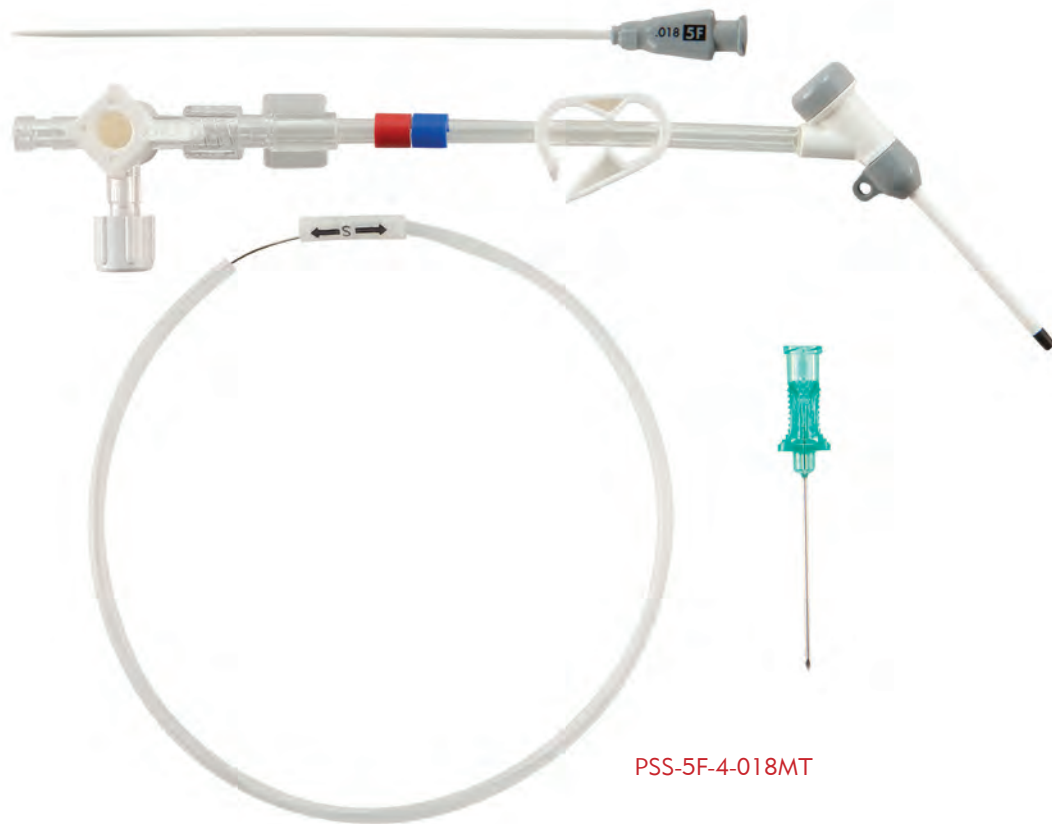

PSS-5F-4-018MT

Catalog Number	French Size	Length	Guide Wire Diameter/length	Needle Gauge/length	Hub Colour	Qty/box
PSS-5F-4-018MT*	5	4 cm	0.018" (0.46 mm) x 40 cm	21G x 4 cm	gray	5
PSS-6F-4-018MT	6	4 cm	0.018" (0.46 mm) x 40 cm	21G x 4 cm	green	5
PSS-7F-4-018MT	7	4 cm	0.018" (0.46 mm) x 40 cm	21G x 4 cm	orange	5
PSS-8F-4-018MT	8	4 cm	0.018" (0.46 mm) x 40 cm	21G x 4 cm	blue	5
PSS-5F-4-035MT**	5	4 cm	0.035" (0.89 mm) x 50 cm	–	gray	5
PSS-6F-4-035MT	6	4 cm	0.035" (0.89 mm) x 50 cm	–	green	5
PSS-7F-4-035MT	7	4 cm	0.035" (0.89 mm) x 50 cm	–	orange	5
PSS-8F-4-035MT	8	4 cm	0.035" (0.89 mm) x 50 cm	–	blue	5
PSS-5F-4-038MT**	5	4 cm	0.038" (0.97 mm) x 50 cm	–	gray	5
PSS-6F-4-038MT	6	4 cm	0.038" (0.97 mm) x 50 cm	–	green	5
PSS-7F-4-038MT	7	4 cm	0.038" (0.97 mm) x 50 cm	–	orange	5
PSS-8F-4-038MT	8	4 cm	0.038" (0.97 mm) x 50 cm	–	blue	5
PSS-5F-4MT	5	4 cm	N/A	–	gray	5
PSS-6F-4MT	6	4 cm	N/A	–	green	5
PSS-7F-4MT	7	4 cm	N/A	–	orange	5
PSS-8F-4MT	8	4 cm	N/A	–	blue	5

* 0.018" Guide wire is stainless steel with straight stainless steel flexible tip.

** 0.035" and 0.038" Guide wires are stainless steel; double ended (3 mm J and floppy).

IMPRESS® 30 CM CATHETERS

Shorter catheter lengths to enable the clinician to be closer to the working site on the forearm while providing excellent torque. Impress catheters feature tapered tips to minimise vessel trauma, accordion hubs to minimise kinking, and a proprietary braid pattern shaft to provide maximum flexibility without compromising steerability.

Catalog Number	French Size	Internal Diameter	Length	# of Side Ports
43035MODCB1	4	.040"/1.02 mm	30 cm	-
43035BER	4	.040"/1.02 mm	30 cm	-
43035KA2	4	.040"/1.02 mm	30 cm	-
43035STR	4	.040"/1.02 mm	30 cm	-
43035RIM	4	.040"/1.02 mm	30 cm	-
4303510PIG-NB	4	.040"/1.02 mm	30 cm	10 non-braided
53035MODCB1	5	.046"/1.17 mm	30 cm	-
53035BER	5	.046"/1.17 mm	30 cm	-
53035KA2	5	.046"/1.17 mm	30 cm	-
53035STR	5	.046"/1.17 mm	30 cm	-
53035RIM	5	.046"/1.17 mm	30 cm	-
5303510PIG-NB	5	.049"/1.25 mm	30 cm	10 non-braided

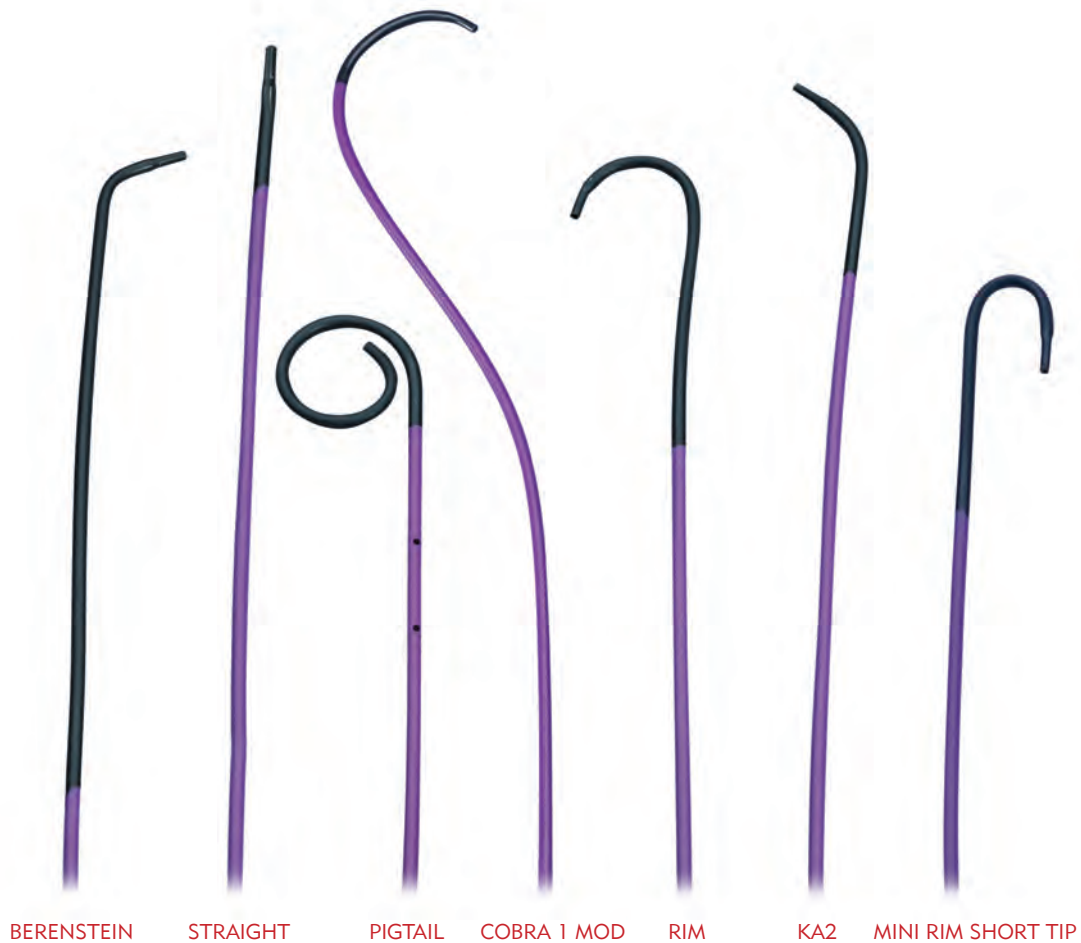
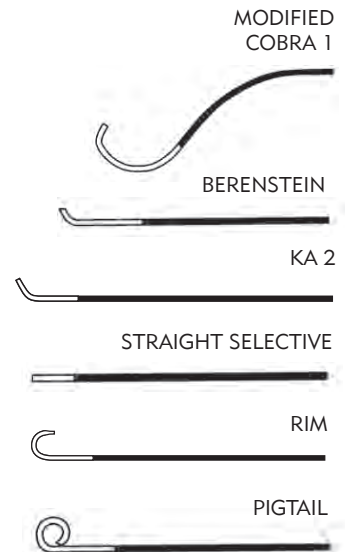

CENTROS® & CENTROSFLO® CATHETERS

The highly innovative catheter design features preformed curved tips which automatically center the catheter ports within the middle of the vessel to maintain optimal blood flow and minimal recirculation rates and enhance overall catheter performance.



CENF19K

Catalog Number	Description	Tip-To-Cuff (cm)	Tip-To-Bifurcation (cm)	Side Holes
CENTROSFLO				
CENF15K	Complete Kit	15	20	yes
CENF17K	Complete Kit	17	22	yes
CENF19K	Complete Kit	19	24	yes
CENF23K	Complete Kit	23	28	yes
CENF27K	Complete Kit	27	32	yes
CENF31K	Complete Kit	31	36	yes
CENF15C	Catheter Only	15	20	yes
CENF17C	Catheter Only	17	22	yes
CENF19C	Catheter Only	19	24	yes
CENF23C	Catheter Only	23	28	yes
CENF27C	Catheter Only	27	32	yes
CENF31C	Catheter Only	31	36	yes
CENTROS				
CEN15K	Complete Kit	15	20	-
CEN17K	Complete Kit	17	22	-
CEN19K	Complete Kit	19	24	-
CEN23K	Complete Kit	23	28	-
CEN27K	Complete Kit	27	32	-
CEN31K	Complete Kit	31	36	-
CEN15C	Catheter Only	15	20	-
CEN17C	Catheter Only	17	22	-
CEN19C	Catheter Only	19	24	-
CEN23C	Catheter Only	23	28	-
CEN27C	Catheter Only	27	32	-
CEN31C	Catheter Only	31	36	-

COMPLETE KIT INCLUDES:

- 1 5F Long-Term Haemodialysis Catheter
- 1 16F Valved Peelaway Sheath and Dilator
- 1 18G x 2.75" (7 cm) Introducer Needle
- 1 #11 Futura® Safety Scalpel
- 1 0.038" x 80 cm J-Tipped Guide Wire
- 2 Adhesive Dressings
- 2 Injection Caps
- 1 12F Vessel Dilator
- 1 14F Vessel Dilator
- 1 Tunneler with Sleeve

CATHETER ONLY INCLUDES:

- 1 15F Long-Term Haemodialysis Catheter
- 2 Injection Caps

PROGUIDE™ CHRONIC DIALYSIS CATHETER

The ProGuide chronic dialysis catheter is designed for optimal patient comfort, ease of insertion and low maintenance. Multiple kit options are available for insertions through a valved peel-away sheath or over-the-wire placements. The ProGuide is available in various catheter lengths.

Catalog Number	Length Tip To Hub (cm)	Length Tip To Cuff (cm)	Side Holes
63124	24	19	yes
63128	28	23	yes
63132	32	27	yes
63136	36	31	yes
63140	40	35	yes
64124	24	19	no
64128	28	23	no
64132	32	27	no
64136	36	31	no
64140	40	35	no

Packaged 5 per box.

CATHETER ONLY INCLUDES:

- 1 14.5F ProGuide Haemodialysis Catheter
- 1 Guide Wire Stylette
- 2 Injection Caps



PROGUIDE™ LONG-TERM HAEMODIALYSIS CATHETER - BASIC KIT

Catalog Number	Length Tip To Hub (cm)	Length Tip To Cuff (cm)	Side Holes
61124	24	19	yes
61128	28	23	yes
61132	32	27	yes
61136	36	31	yes
61140	40	35	yes
62124	24	19	no
62128	28	23	no
62132	32	27	no
62136	36	31	no
62140	40	35	no

Packaged 5 per box

BASIC KIT INCLUDES:

- 1 14.5F ProGuide Haemodialysis Catheter
- 1 Guide Wire Stylette
- 2 Injection Caps
- 1 12F Vessel Dilator
- 1 14F Vessel Dilator
- 1 Tunneler with Sleeve

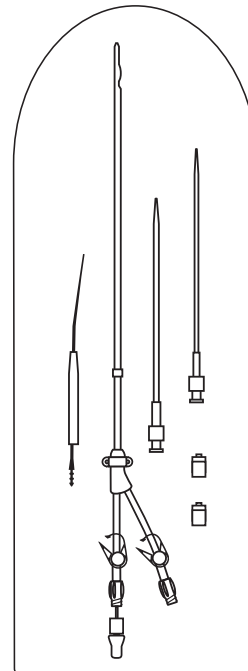

PROGUIDE™ HAEMODIALYSIS CATHETER - COMPLETE KIT

Catalog Number	Length Tip To Hub (cm)	Length Tip To Cuff (cm)	Side Holes
DC21452419	24	19	yes
DC21452823	28	23	yes
DC21453227	32	27	yes
DC21453631	36	31	yes
DC21454035	40	35	yes
DC21455550	55	50	yes
DC01452419	24	19	no
DC01452823	28	23	no
DC01453227	32	27	no
DC01453631	36	31	no
DC01454035	40	35	no
DC01455550	55	50	no

Packaged 5 per box.

COMPLETE KIT INCLUDES:

- 1 14.5F ProGuide Chronic Dialysis Catheter
- 1 Guide Wire Stylette
- 1 15F Valved Peelaway Sheath and Dilator
- 1 18 G x 2.75" (7 cm) Introducer Needle
- 1 #11 Futura® Safety Scalpel
- 1 0.038" (0.97 mm) J-Tipped Marker Guide Wire
- 2 Adhesive Dressings
- 2 Injection Caps
- 1 12F Vessel Dilator
- 1 14F Vessel Dilator
- 1 Tri-Ball Tunneler with Sleeve

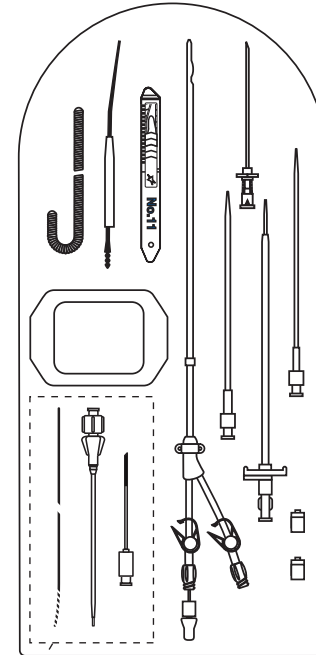

**MAK (MINI ACCESS KIT) INCLUDES:

- 1 5F (1.7 mm) x 10 cm Co-Axial Introducer
- 1 21G x 7 cm Echo-Enhanced Needle
- 1 0.018" (0.46 mm) x 40 cm Nitinol Wire with Platinum Tip

PROGUIDE™ HAEMODIALYSIS CATHETER - COMPLETE KIT WITH MINI ACCESS KIT

Catalog Number	Length Tip To Hub (cm)	Length Tip To Cuff (cm)	Side Holes
DC21452419-NE5	24	19	yes
DC21452823-NE5	28	23	yes
DC21453227-NE5	32	27	yes
DC01452419-NE5	24	19	no
DC01452823-NE5	28	23	no
DC01453227-NE5	32	27	no

Packaged 5 per box.

OUTAKE® CATHETER EXTRACTION TOOL

The OuTake catheter extraction tool is a convenient, simple, and cost-effective device used to remove tunneled, double lumen haemodialysis catheters with an in-growth cuff. Packaged 5 per box.



Catalog Number

CET100	Stand Alone OuTake Catheter Extractor
CET200	Catheter Extraction Kit with OuTake
CET300	Catheter Extraction Kit with OuTake

PERITONEAL DIALYSIS CATHETERS

Merit Medical's line of Flex-Neck® Adult, Adolescent and Pediatric Peritoneal Dialysis Catheters have an internal diameter (ID) that is 35% larger than some competing catheters. Infant catheters are available in one and two cuff configurations. Each catheter kit contains a unique stenciling system for improved placement accuracy.

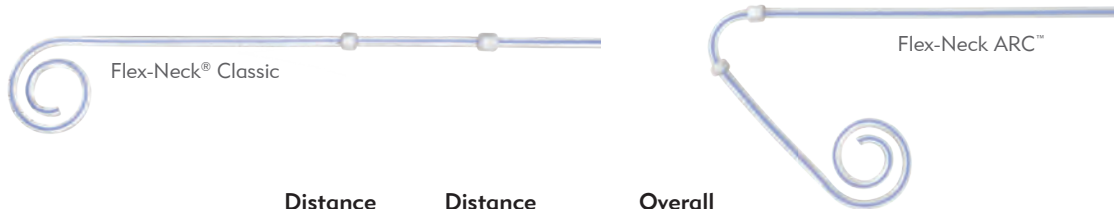

Catalog Number	O.D. (mm)	I.D. (mm)	Distance Between Cuffs (cm)	Distance From Distal Cuff To Coil (cm)	Overall Length Straightened (cm)	Description
FLEX-NECK® INFANT COILED						
CF-4230	3.7	2.5	3	4.5	42	Classic, 2 cuffs
CF-4235	3.7	2.5	-	4.5	42	Classic, 1 cuff
CF-4430	3.7	2.5	3	4.5	42	ARC, 2 cuffs
FLEX-NECK PEDIATRIC COILED						
CF-5242	5.3	3.5	4	6.5	52	Classic, 2 cuffs
CF-5247	5.3	3.5	-	6.5	52	Classic, 1 cuff
CF-5442	5.3	3.5	4.5	6.5	52	ARC, 2 cuffs
FLEX-NECK ADOLESCENT COILED						
CF-5243	5.3	3.5	4.5	9.5	62	Classic Standard, 2 cuffs
CF-5244	5.3	3.5	-	9.5	62	Classic Standard, 1 cuff
CF-5249	5.3	3.5	-	13.5	62	Classic Large, 1 cuff
CF-5443	5.3	3.5	4.5	9.5	62	ARC, 2 cuffs
FLEX-NECK CLASSIC ADULT COILED						
CF-5250	5.3	3.5	5	14	62	Small, 2 Cuff
CF-5260	5.3	3.5	6	15.5	62	Standard, 2 Cuff
CF-5270	5.3	3.5	7	16.5	62	Large, 2 Cuff
FLEX-NECK CLASSIC ADULT STRAIGHT						
CF-5161	5.3	3.5	6	15.5	52	Standard, 2 Cuff (Distal Cuff to Tip)
FLEX-NECK ARC™ ADULT COILED						
CF-5450	5.3	3.5	6	14	62	Small, 2 Cuff
CF-5460	5.3	3.5	6	15.5	62	Standard, 2 Cuff
CF-5470	5.3	3.5	6	16.5	62	Large, 2 Cuff
FLEX-NECK EXXTENDED™ COILED ADULT						
CF-5560	5.3	3.5	-	16	62	

PERITONEAL DIALYSIS ACCESSORIES & IMPLANTATION SYSTEMS

Merit Medical offers a comprehensive line of Peritoneal Dialysis Catheters, Accessories, Implantation Systems, and an Embedding Tool to streamline your PD placement procedures.

Catalog Number	Description
CC-1301	PD Accessories, Plastic Catheter Connector and Cap, Adult/Adolescent/Pediatric
CC-1360	PD Accessories, Plastic Catheter Connector and Cap, Infant Only
CC-2300	PD Accessories, Titanium Catheter Connector, Adult
CE-1400	PD Accessories, Catheter Extender/Repair Kit, All Catheter Types
CS-242	PD Accessories, Catheter Implantation Stylette, Infant, Stainless Steel, 42 cm, Non-Sterile
CS-352	PD Accessories, Catheter Implantation Stylette, Adult Straight/Pediatric, Stainless Steel, 52 cm, Non-Sterile
CS-362	PD Accessories, Catheter Implantation Stylette, Adolescent/Adult, Coiled Stainless Steel, 62 cm, Non-Sterile
FT-1100	PD Accessories, Faller Trocar, Stainless Steel
IA-102	PD Accessories, Insufflation Kit
TE-1000	PD Accessories, Embedding® Tool
VP-210	Peritoneoscopic and Laparoscopic, Implantation System CE Mark only
VP-511	Peritoneoscopic Implantation System

VP-210 Implantation System

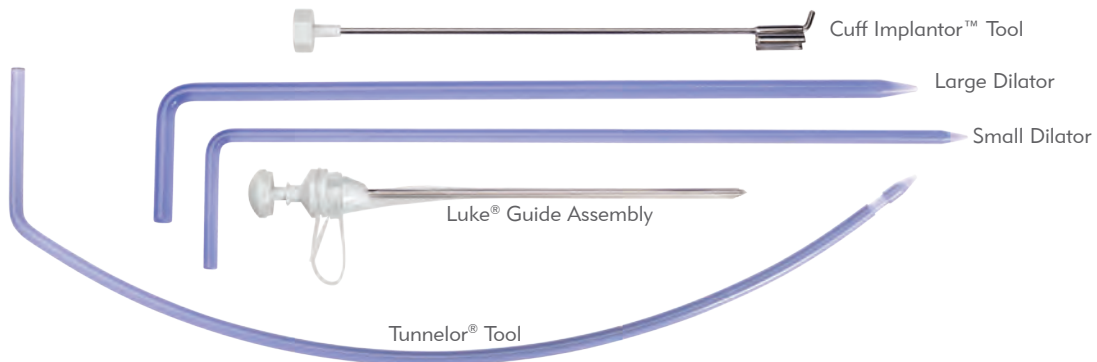

VP-511 Peritoneoscopic Implantation System

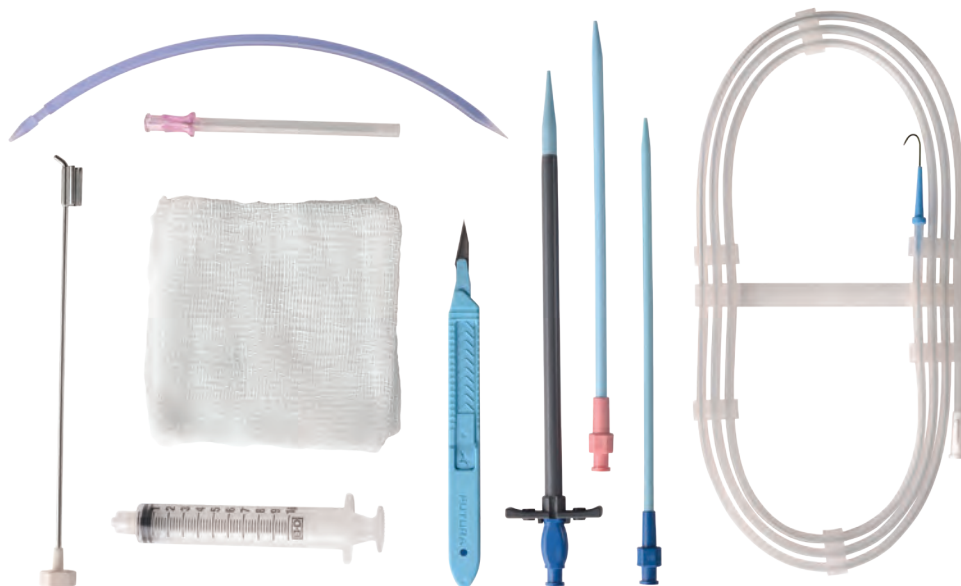

SLIP-NOT® SUTURE RETENTION DEVICE

The Slip-Not® suture retention device helps manage bleeding by utilising a novel method to secure your purse-string suture. Suture tension adjustments are achieved at the push of a button. The Slip-Not provides clear visibility of the access site and enhanced patient comfort. Packaged 1 or 2 units per pouch, 10 pouches per box.

Easy, Step-by-Step Instructions



Place purse-string suture around the sheath; feed free ends of the suture through the snare loop of the device.

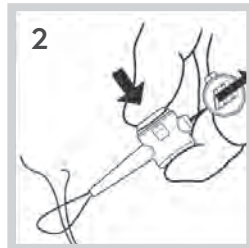

Depress the white button; pull the green tab to thread the free ends of the suture through the device. Discard green pull tab.

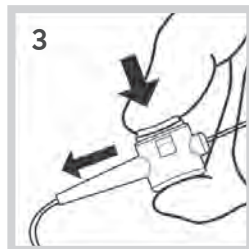

Depress the white button and slide the SLIP-NOT® forward to produce tension. Release the white button to secure the suture within the device.



Catalog Number

SRD100	1 per pouch
SRD200	2 per pouch

4 FRENCH FOUNTAIN® INFUSION SYSTEMS

Fountain Infusion System consists of the 4 French Fountain Infusion Catheter, matching occluding wire, high pressure check relief valve, AccessPLUS haemostasis valve, 1 mL infusion syringe and 20 mL reservoir syringe. Packaged and sold individually in tray, 5 units per box.



Catheter Length	Infusion Length 5 cm	Infusion Length 10 cm	Infusion Length 20 cm	Infusion Length 30 cm	Infusion Length 40 cm	Infusion Length 50 cm
45 cm		FIS4-45-10	FIS4-45-20			
90 cm	FIS4-90-5	FIS4-90-10	FIS4-90-20	FIS4-90-30	FIS4-90-40	FIS4-90-50
135 cm	FIS4-135-5	FIS4-135-10	FIS4-135-20	FIS4-135-30	FIS4-135-40	FIS4-135-50

4 FRENCH FOUNTAIN® INFUSION SYSTEMS WITH SQUIRT

Fountain Infusion System with Squirt consists of the 4 French Fountain Infusion Catheter, matching occluding wire, AccessPLUS haemostasis valve, 20 mL reservoir syringe and Squirt Fluid Dispensing System. Packaged and sold individually in tray, 5 units per box.

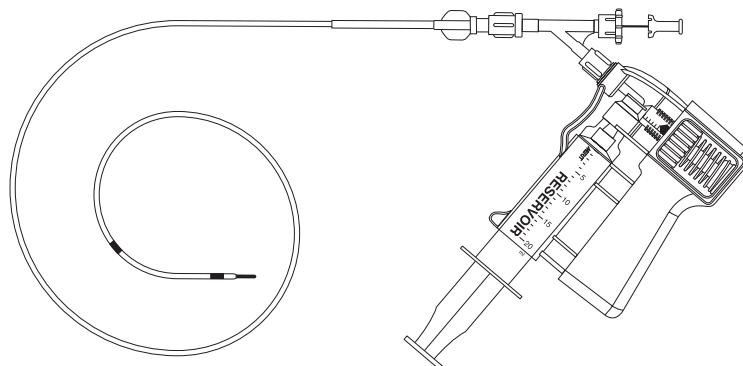

Catheter Length	Infusion Length 5 cm	Infusion Length 10 cm	Infusion Length 20 cm	Infusion Length 30 cm	Infusion Length 40 cm	Infusion Length 50 cm
45 cm		FIS4-45-10SQ	FIS4-45-20SQ			
90 cm	FIS4-90-5SQ	FIS4-90-10SQ	FIS4-90-20SQ	FIS4-90-30SQ	FIS4-90-40SQ	FIS4-90-50SQ
135 cm	FIS4-135-5SQ	FIS4-135-10SQ	FIS4-135-20SQ	FIS4-135-30SQ	FIS4-135-40SQ	FIS4-135-50SQ

5 FRENCH FOUNTAIN® INFUSION SYSTEMS

Fountain Infusion System consists of the 5 French Fountain Infusion Catheter, matching occluding wire, high pressure check relief valve, AccessPLUS™ haemostasis valve, wire protector cap, 1 mL infusion syringe and 20 mL reservoir syringe. Packaged and sold individually in tray, 5 units per box.

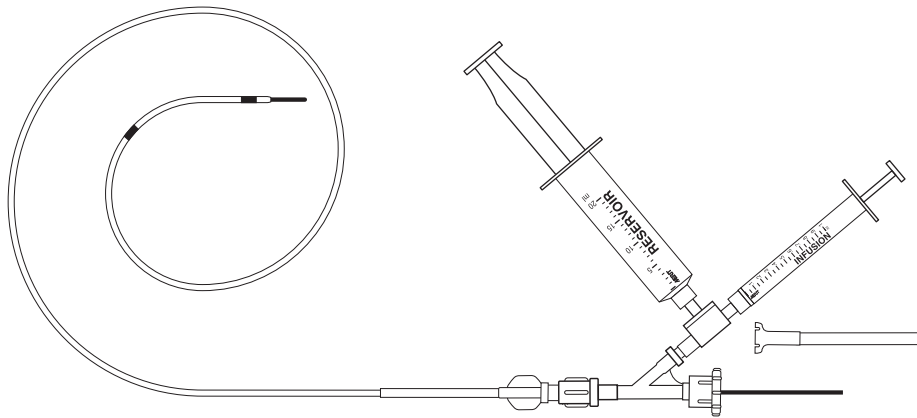

Catheter Length	Infusion Length 5 cm	Infusion Length 10 cm	Infusion Length 20 cm	Infusion Length 30 cm	Infusion Length 40 cm	Infusion Length 50 cm
45 cm		FIS5-45-10	FIS5-45-20			
90 cm	FIS5-90-5	FIS5-90-10	FIS5-90-20	FIS5-90-30	FIS5-90-40	FIS5-90-50
135 cm	FIS5-135-5	FIS5-135-10	FIS5-135-20	FIS5-135-30	FIS5-135-40	FIS5-135-50

5 FRENCH FOUNTAIN® INFUSION SYSTEMS WITH SQUIRT

Fountain Infusion System with Squirt consists of the 5 French Fountain Infusion Catheter, matching occluding wire, AccessPLUS haemostasis valve, wire protector cap, 20 mL reservoir syringe and Squirt Fluid Dispensing System. Packaged and sold individually in tray, 5 units per box.

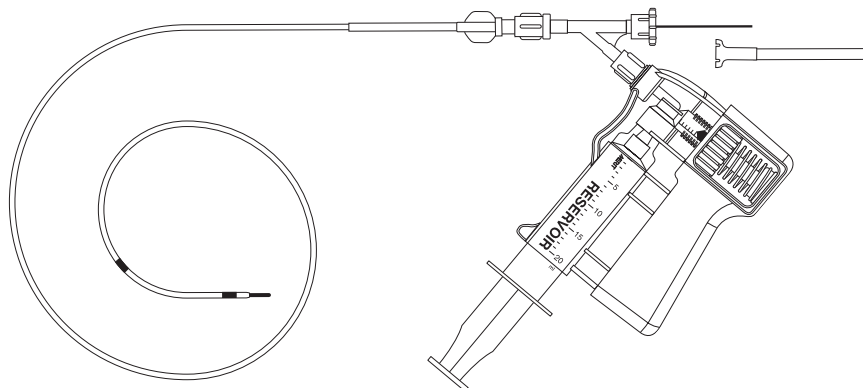

Catheter Length	Infusion Length 5 cm	Infusion Length 10 cm	Infusion Length 20 cm	Infusion length 30 cm	Infusion Length 40 cm	Infusion Length 50 cm
45 cm		FIS5-45-10SQ	FIS5-45-20SQ			
90 cm	FIS5-90-5SQ	FIS5-90-10SQ	FIS5-90-20SQ	FIS5-90-30SQ	FIS5-90-40SQ	FIS5-90-50SQ
135 cm	FIS5-135-5SQ	FIS5-135-10SQ	FIS5-135-20SQ	FIS5-135-30SQ	FIS5-135-40SQ	FIS5-135-50SQ

FOUNTAIN® INFUSION CATHETERS

FOUNTAIN INFUSION CATHETER (4 FRENCH) matching occluding wire and AccessPLUS haemostasis valve. Packaged and sold individually in a pouch, 5 units per box.

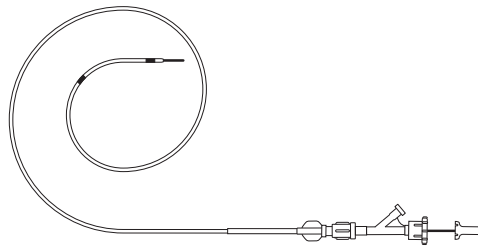

Catheter Length	Infusion Length 5 cm	Infusion Length 10 cm	Infusion Length 20 cm	Infusion Length 30 cm	Infusion Length 40 cm	Infusion Length 50 cm
45 cm		IS4-45-10	IS4-45-20			
90 cm	IS4-90-5	IS4-90-10	IS4-90-20	IS4-90-30	IS4-90-40	IS4-90-50
135 cm	IS4-135-5	IS4-135-10	IS4-135-20	IS4-135-30	IS4-135-40	IS4-135-50

FOUNTAIN INFUSION CATHETER (5 FRENCH) matching occluding wire, AccessPLUS haemostasis valve, and wire protector cap. Packaged and sold individually in a pouch, 5 units per box.

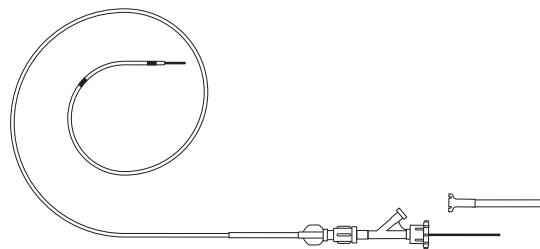

Catheter Length	Infusion Length 5 cm	Infusion Length 10 cm	Infusion Length 20 cm	Infusion Length 30 cm	Infusion Length 40 cm	Infusion Length 50 cm
45 cm		IS5-45-10	IS5-45-20			
90 cm	IS5-90-5	IS5-90-10	IS5-90-20	IS5-90-30	IS5-90-40	IS5-90-50
135 cm	IS5-135-5	IS5-135-10	IS5-135-20	IS5-135-30	IS5-135-40	IS5-135-50

FOUNTAIN® OCCLUDING WIRES

The Fountain occluding wire effectively blocks off the end hole of the catheter so the therapeutic agent is directed out the side holes into the thrombus. Packaged and sold individually in a pouch, 5 units per box.

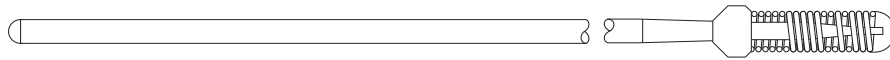

	Length 45 cm	Length 90 cm	Length 135 cm
4F Wire	FW4-45	FW4-90	FW4-135
5F Wire	FW5-45	FW5-90	FW5-135

SQUIRT® FLUID DISPENSING SYSTEM

Squirt Fluid Dispensing System for the pulsed injection of multiple dose therapy. Packaged 10 units per box.

Catalog Number FDS100

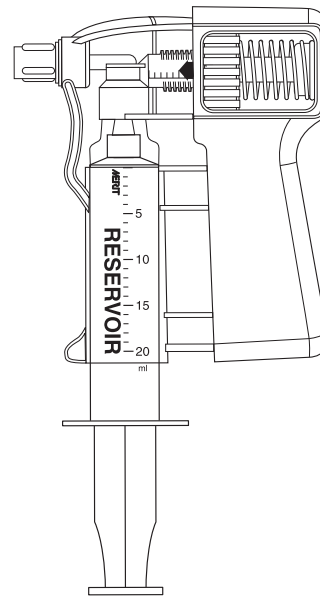

PULSE INFUSION KITS

Pulse Infusion Kits are designed to be used with the Fountain® and Mistique® infusion catheters. Products are available with 1 mL infusion syringe, 20 mL reservoir syringe, and check relief valve; some kits also contain a haemostasis valve.

PULSE INFUSION KIT consists of in-line check relief valve, AccessPLUS™ haemostasis valve, 1 mL infusion syringe and 20 mL reservoir syringe. Packaged 5 units per box.

Catalog Number K12-00462

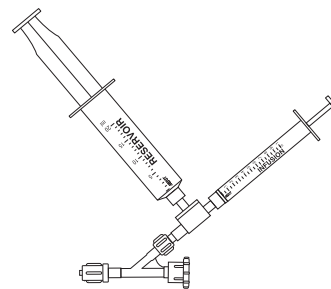

PULSE INFUSION KIT consists of in-line check relief valve, 1 mL infusion syringe and 20 mL reservoir syringe. Packaged 5 units per box.

Catalog Number K12-00463

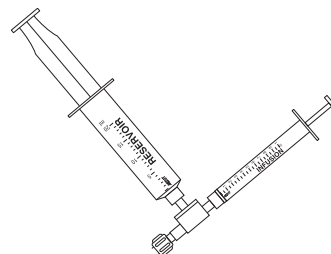

PULSE INFUSION KITS

PULSE INFUSION KIT consists of check relief valve, 1 mL infusion syringe and 20 mL reservoir syringe. Packaged 5 units per box.

Catalog Number K12-00262

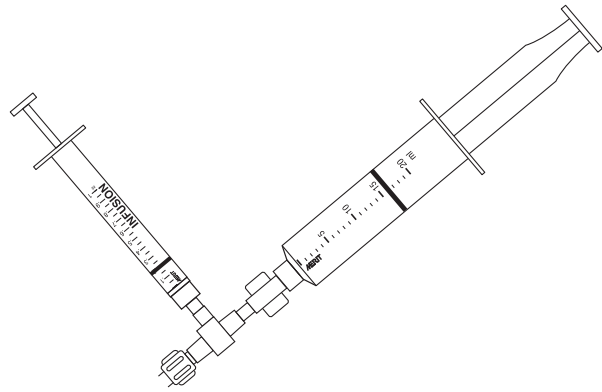

MISTIQUE® INFUSION CATHETERS

The Mistique infusion catheter is a 5 French catheter with side holes rotating around the catheter for a more uniform distribution of therapeutic solutions. One configuration to accommodate 0.035" (0.89 mm) guide wire. Packaged and sold individually, 5 units per box.

Catheter Length	Infusion Length 5 cm	Infusion Length 10 cm
MAXIMUM GUIDE WIRE 0.035" (0.89 mm)		
45 cm	MIC5-45-5-035	MIC5-45-10-035
90 cm	MIC5-90-5-035	MIC5-90-10-035
135 cm	MIC5-135-5-035	MIC5-135-10-035

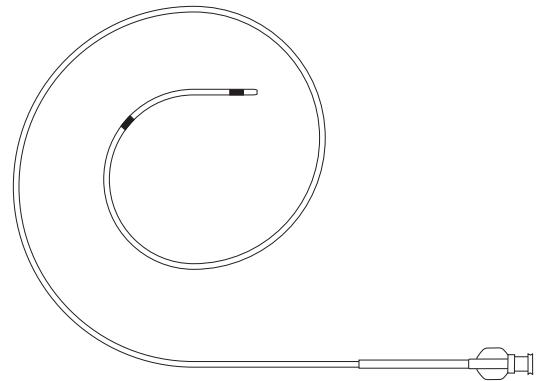

INTERVENTION



PERIPHERAL INTERVENTION

EMBOLOTHERAPY

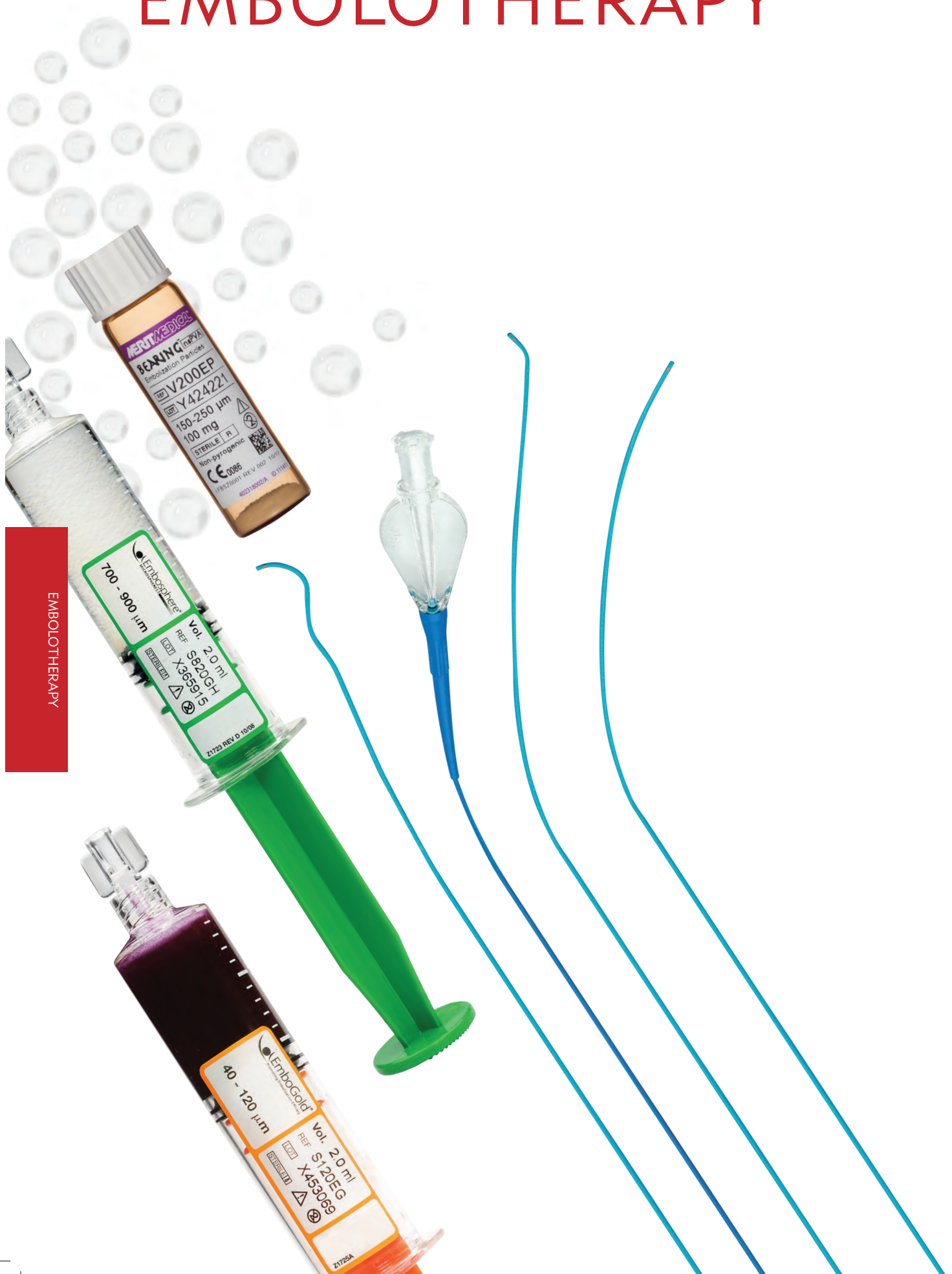

EMBOLOTHERAPY

MICROSPHERES

EmboGold® Microspheres	93
Embosphere® Microspheres	93
Bearing nsPVA® Embolisation Particles	94

DELIVERY SYSTEMS

Merit Maestro® Microcatheters	95
Tenor® Steerable Guide Wires	96
Impress® Uterine Artery Catheter	96

EMBOGOLD® MICROSPHERES

EmboGold Microspheres bring visibility to Merit Medical's proven microsphere technology. Provided in a pre-filled syringe for easy handling, procedural efficiency, and safety in the treatment of hypervascular tumours or arteriovenous malformations. EmboGold Microspheres are made from trisacryl cross-linked with gelatin and impregnated with 2% elemental gold for visibility. The microspheres can compress up to 33% to facilitate passage through various microcatheters and may minimise unwanted proximal embolisation and unpredictable distal embolisation.

Size Range (µm)	Colour Code	Pre-Filled Syringe 1 mL*	Pre-Filled Syringe 2 mL*
40 - 120	Orange	-	S120EG
100 - 300	Yellow	S210EG	S220EG
300 - 500	Blue	S410EG	S420EG
500 - 700	Red	S610EG	S620EG
700 - 900	Green	S810EG	S820EG
900 - 1200	Purple	S1010EG	S1020EG

Packaged one (1) per box.

* Volume of microspheres supplied in sterile saline.

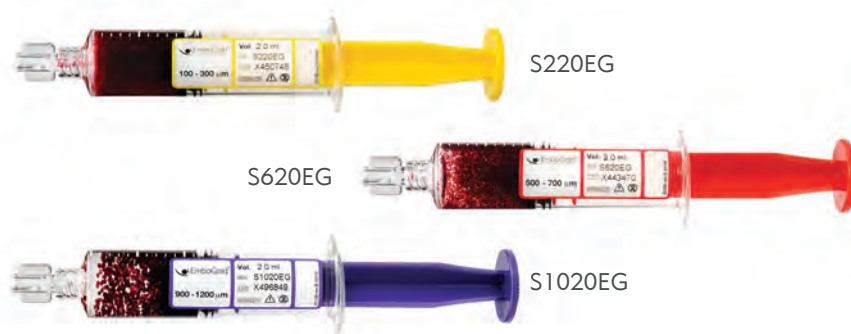

EMBOSPHERE® MICROSPHERES

Embosphere Microspheres, the most clinically studied round embolic, provide results for effective embolisation in the treatment of uterine fibroids, hypervascular tumours or arteriovenous malformations. Embosphere Microspheres are made from trisacryl cross-linked with gelatin and can compress up to 33% to facilitate passage through various microcatheters and may minimise unwanted proximal embolisation and unpredictable distal embolisation.

Size Range (µm)	Colour Code	Pre-Filled Syringe 1 mL*	Pre-Filled Syringe 2 mL*	Vials 1 mL*	Vials 2 mL*
40 - 120	Orange	-	S120GH	V110GH	V120GH
100 - 300	Yellow	S210GH	S220GH	V210GH	V220GH
300 - 500	Blue	S410GH	S420GH	V410GH	V420GH
500 - 700	Red	S610GH	S620GH	V610GH	V620GH
700 - 900	Green	S810GH	S820GH	V810GH	V820GH
900 - 1200	Purple	S1010GH	S1020GH	V1010GH	V1020GH

Packaged one (1) per box.

*Volume of microspheres supplied in sterile saline.

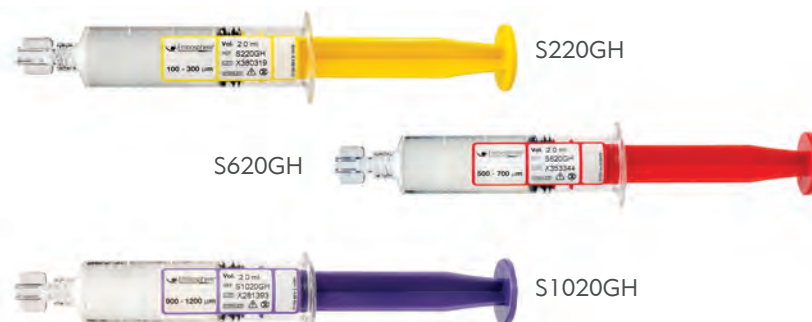

BEARING NSPVA® EMBOLISATION PARTICLES

Bearing nsPVA Embolisation Particles are irregularly-shaped, biocompatible, hydrophilic, nonresorbable particles produced from polyvinyl alcohol. These embolisation particles are intended to provide vascular occlusion or reduction of blood flow within target vessels upon selective placement through a variety of catheters.



Catalog Number	Size Range (µm)	Vial Content
V100EP	45 - 150	100 mg
V200EP	150 - 250	100 mg
V300EP	250 - 355	100 mg
V400EP	355 - 500	100 mg
V600EP	500 - 710	100 mg
V800EP	710 - 1000	100 mg
V1100EP	1000 - 1180	100 mg

MERIT MAESTRO® MICROCATHETERS

The Merit Maestro is a multipurpose microcatheter designed for use in peripheral and coronary vasculature. It features a hydrophilic coating for smooth traction through tortuous anatomy, a radiopaque marker for easy identification of the distal tip, and an exclusive swan neck design to help seat the catheter in the vessel reducing the recoiling effect of the embolic agent as it is introduced.

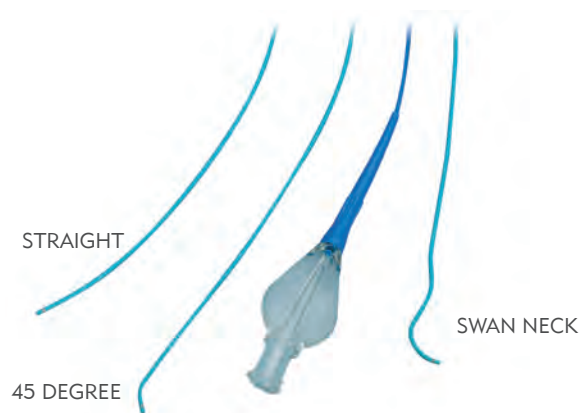

Catalog Number	Proximal	Distal	Length cm	Tip	Minimum Inner Diameter	Recommended Guide Wire	Recommended Guiding Catheter
2.8F TAPERED TO 2.4F							
28MC24110ST	2.8	2.4	110	Straight	.020" (0.52 mm)	.018" (0.46 mm)	.040" (1.02 mm)
28MC24130ST	2.8	2.4	130	Straight	.020" (0.52 mm)	.018" (0.46 mm)	.040" (1.02 mm)
28MC24150ST	2.8	2.4	150	Straight	.020" (0.52 mm)	.018" (0.46 mm)	.040" (1.02 mm)
28MC2411045	2.8	2.4	110	45 degree	.020" (0.52 mm)	.018" (0.46 mm)	.040" (1.02 mm)
28MC2413045	2.8	2.4	130	45 degree	.020" (0.52 mm)	.018" (0.46 mm)	.040" (1.02 mm)
28MC2415045	2.8	2.4	150	45 degree	.020" (0.52 mm)	.018" (0.46 mm)	.040" (1.02 mm)
28MC24110SN	2.8	2.4	110	Swan Neck	.020" (0.52 mm)	.018" (0.46 mm)	.040" (1.02 mm)
28MC24130SN	2.8	2.4	130	Swan Neck	.020" (0.52 mm)	.018" (0.46 mm)	.040" (1.02 mm)
28MC24150SN	2.8	2.4	150	Swan Neck	.020" (0.52 mm)	.018" (0.46 mm)	.040" (1.02 mm)

2.8F NO TAPER

28MC28110ST	2.8	2.8	110	Straight	.024" (0.62 mm)	.021" (0.53 mm)	.040" (1.02 mm)
28MC28130ST	2.8	2.8	130	Straight	.024" (0.62 mm)	.021" (0.53 mm)	.040" (1.02 mm)
28MC28150ST	2.8	2.8	150	Straight	.024" (0.62 mm)	.021" (0.53 mm)	.040" (1.02 mm)
28MC2811045	2.8	2.8	110	45 degree	.024" (0.62 mm)	.021" (0.53 mm)	.040" (1.02 mm)
28MC2813045	2.8	2.8	130	45 degree	.024" (0.62 mm)	.021" (0.53 mm)	.040" (1.02 mm)
28MC2815045	2.8	2.8	150	45 degree	.024" (0.62 mm)	.021" (0.53 mm)	.040" (1.02 mm)
28MC28110SN	2.8	2.8	110	Swan Neck	.024" (0.62 mm)	.021" (0.53 mm)	.040" (1.02 mm)
28MC28130SN	2.8	2.8	130	Swan Neck	.024" (0.62 mm)	.021" (0.53 mm)	.040" (1.02 mm)
28MC28150SN	2.8	2.8	150	Swan Neck	.024" (0.62 mm)	.021" (0.53 mm)	.040" (1.02 mm)

2.9F NO TAPER

29MC29110ST	2.9	2.9	110	Straight	.027" (0.68 mm)	.021" (0.53 mm)	.042" (1.07 mm)
29MC29130ST	2.9	2.9	130	Straight	.027" (0.68 mm)	.021" (0.53 mm)	.042" (1.07 mm)
29MC29150ST	2.9	2.9	150	Straight	.027" (0.68 mm)	.021" (0.53 mm)	.042" (1.07 mm)
29MC2911045	2.9	2.9	110	45 degree	.027" (0.68 mm)	.021" (0.53 mm)	.042" (1.07 mm)
29MC2913045	2.9	2.9	130	45 degree	.027" (0.68 mm)	.021" (0.53 mm)	.042" (1.07 mm)
29MC2915045	2.9	2.9	150	45 degree	.027" (0.68 mm)	.021" (0.53 mm)	.042" (1.07 mm)
29MC29110SN	2.9	2.9	110	Swan Neck	.027" (0.68 mm)	.021" (0.53 mm)	.042" (1.07 mm)
29MC29130SN	2.9	2.9	130	Swan Neck	.027" (0.68 mm)	.021" (0.53 mm)	.042" (1.07 mm)
29MC29150SN	2.9	2.9	150	Swan Neck	.027" (0.68 mm)	.021" (0.53 mm)	.042" (1.07 mm)

All Merit Maestro Microcatheters are rated to 800 psi infusion dynamic pressure.
 (1) Radiopaque Marker Band 80 cm Hydrophilic Coating includes (2) 3 mL Medallion syringes
 Microcatheters sold individually.

TENOR® STEERABLE MICRO WIRE

The Tenor Steerable Micro Wire is designed to offer excellent pushability and torqueability to facilitate precise navigation in challenging anatomy during embolisation procedures. Packaged with an insertion tool and torque device.

Catalog Number	Description	Size	Length cm	Tip Material	Core	# Per Box
TNR2411	Angled Tip	0.014" (0.36 mm)	165	Platinum Coiled	F	1
TNR2412	Straight Tip	0.014" (0.36 mm)	165	Platinum Coiled	F	1
TNR2811	Angled Tip	0.018" (0.46 mm)	165	Platinum Coiled	F	1
TNR2812	Straight Tip	0.018" (0.46 mm)	165	Platinum Coiled	F	1

STEERABLE GUIDE WIRE/MICROCATHETER PACKS

K16-00002 28MC24130ST Maestro® with TNR2811 Tenor Steerable Guide Wire

K16-00003 28MC24150ST Maestro with TNR2811 Tenor Steerable Guide Wire



TNR2411

IMPRESS® UTERINE ARTERY CATHETER

Designed to deliver radiopaque media, Impress catheters feature tapered tips to minimise vessel trauma, an accordion designed hub to minimise kinking, and a proprietary braid pattern shaft to provide maximum flexibility without compromising steerability. The Impress Uterine Artery Catheter is shaped to aid in the treatment of uterine fibroid embolisation.

Catalog Number	French Size	Internal Diameter	Recommended Guide Wire	Length
59038UAC	5	.046"/1.17 mm	.038" (0.97 mm)	90 cm

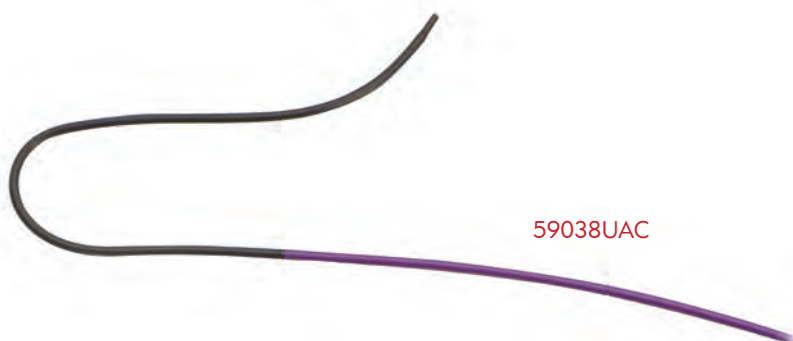

59038UAC



PERIPHERAL INTERVENTION

ONCOLOGY



ONCOLOGY

HEPASPHERE™ MICROSPHERES

Doxorubicin-loaded HepaSpheres® Microspheres have demonstrated success in the treatment of Hepatocellular Carcinoma (HCC) with high-objective tumour response while minimising the impact to underlying healthy liver function.¹ HepaSpheres Microspheres are reconstituted with saline or non-ionic contrast media and immediately swell to 4x their dry state diameter. These highly compressible microspheres facilitate outstanding contact with the vessel intima.

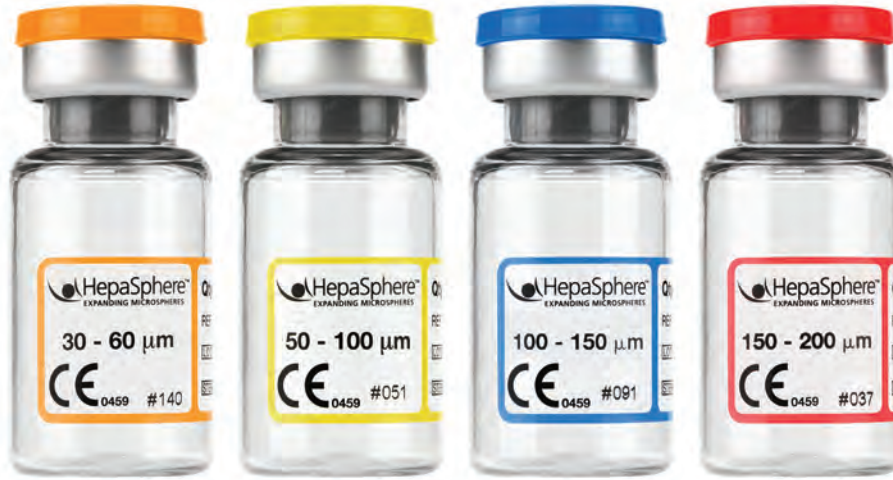

Catalog Number	Size Range Dry Particles (µm)	Size Range When Expanded (µm)	Colour Code	Quantity (mg)
V225HS	30 - 60	120 - 240	Orange	25 mg
V325HS	50 - 100	200 - 400	Yellow	25 mg
V525HS	100 - 150	400 - 600	Blue	25 mg
V725HS	150 - 200	600 - 800	Red	25 mg

Packaged one (1) per box.

HepaSpheres Microspheres are not approved or available for sale in the United States.

¹Data on file.



PERIPHERAL INTERVENTION

COMPLETE PROCEDURAL SOLUTIONS



COMPLETE PROCEDURAL
SOLUTIONS

PROCEDURAL TRAYS, PACKS & KITS

Biopsy Centesis Kits	101
Medication Delivery Pack 1	102
Medication Delivery Pack 2	102
Myelogram Tray	103
Vein Closure Tray	104
Vein Closure Syringe	104
Patient Cover	105
Drape Armour® - Scatter Radiation Drapes	105

SAFETY & WASTE MANAGEMENT

Merit Disposal Depot™ Waste Bags	106-108
----------------------------------	---------

HAEMOSTASIS ACCESSORIES

Clo-Sur P.A.D.® & Clo-Sur ^{PLUS} P.A.D.™	109
SafeGuard® Pressure Assisted Device	109
Haemostasis Valve Adapter	110

BIOPSY CENTESIS KITS

BIOPSY/CENTESIS - COMPLETE KIT

The complete kit is designed to provide many of the products needed for biopsy procedures.

Includes

Quantity	Description
1	Lidocaine, 2% 20 mL MDV (plastic)
1	Bandage, 0.75"x 3" Sheer
1	Syringe 10 mL L/L
1	Syringe 20 mL L/L
1	Safety Needle 25G x 1.5"
1	ChlorPrep®, 3 mL Tinted/Orange
1	Ruler, 6"
1	Drape, 22" x 22" w/3.5" Fenestration & Ripline
1	Tray, 3-Compartment
1	ShortStop (SS10P)
1	#11 Futura® Safety Scalpel
1	Safety Needle 18G x 1.5"
1	Towel
1	Lidocaine, Label, 0.5 x 1.75
10	Sponge Gauzes 4" X 4" 12 ply

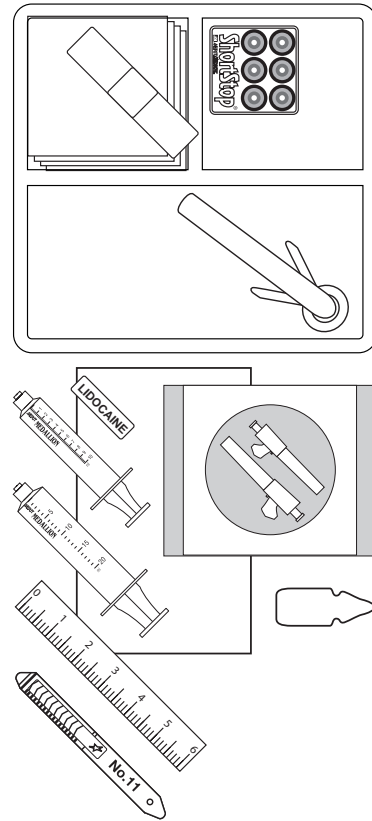

Packaged 10 per case.

Catalog Number K12T-04322

BIOPSY/CENTESIS - BASIC KIT

The basic kit is designed to provide commonly used products needed for biopsy procedures.

Includes

Quantity	Description
1	Bandage, 0.75"x 3"
1	Syringe 10 mL L/L
1	Syringe 20 mL L/L
1	ChlorPrep®, 3 mL Tinted/Orange
1	Drape, 22" x 22" w/3.5" Fenestration & Ripline
1	Tray, 9" x 5" x 1"
1	Safety Needle 22G x 1.5"
1	Safety Needle 18G x 1"
1	Label, Lidocaine (blue)
10	Sponge Gauzes 4" X 4" 12 ply

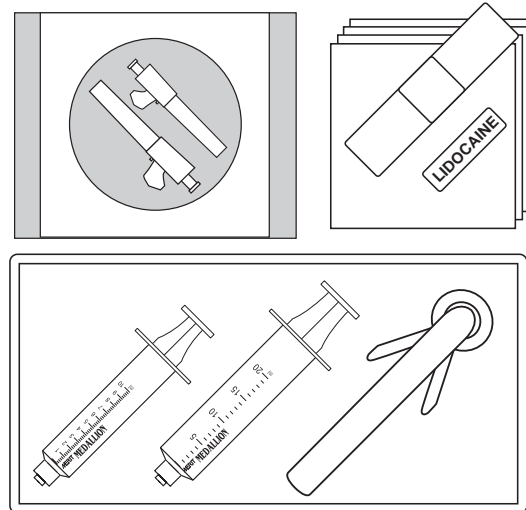

Packaged 30 per case.

Catalog Number K12T-04321

Biopsy Centesis Kits do not have CE Marking.
ChlorPrep® is a registered trademark of CareFusion 2200, Inc.

MEDICATION DELIVERY PACK 1

Includes

Quantity	Description
1	Marquis® Series Stopcock 3-Way, Rotator, 500 PSI
1	PAL™ (Pen and Labels) Blank Label Set of 12
1	Ultra Fine Point Permanent Marker
1	250 mL Solution Bowl
1	Tray 9" x 10" x 2"
1	Table Cover 44" x 78"
1	3-Way Metal Stopcock
2	Syringes (Glass) 10 mL L/L
3	Syringes (Glass) 5 mL L/L
1	Half Drape 44" x 55"

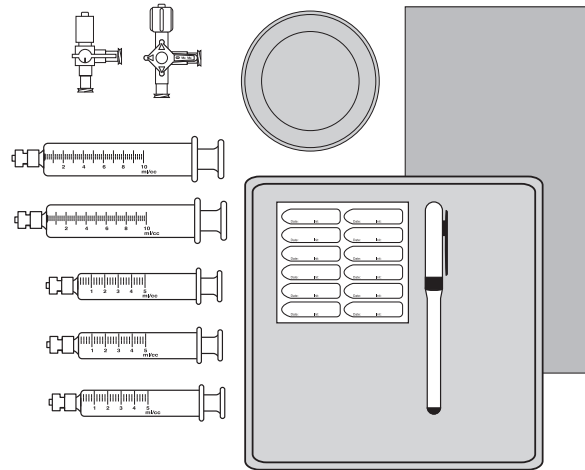

Packaged 6 per case.

Catalog Number K12T-02843

MEDICATION DELIVERY PACK 2

Includes

Quantity	Description
1	250 mL Solution Bowl
1	Table Cover 44" x 78"
1	Ultra Fine Point Permanent Marker
3	Medallion® Syringes, 3 mL, L/L, Red with Frosted Cliché
2	Medallion Syringes, 10 mL, L/L, Yellow with Frosted Cliché
1	Marquis® Series Stopcock 3-Way, Rotator, 500 PSI
1	3-Way Metal Stopcock
1	Half Drape 44" x 55"

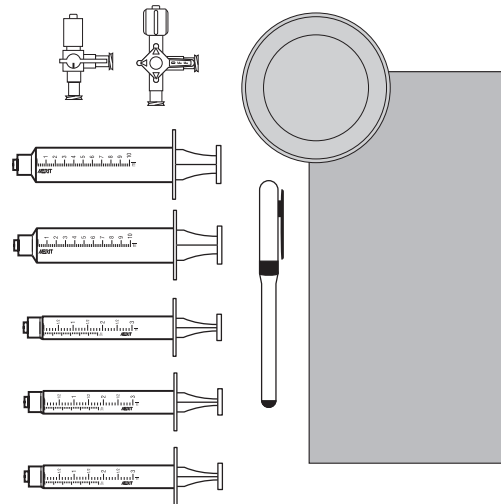

Packaged 6 per case.

Catalog Number K12T-02844

Medication Delivery Packs do not have CE Marking.

MYELOGRAM TRAY

The tray is designed with all the necessary components to streamline myelogram procedures. Components are strategically placed in a clear form-fitted tray for easy access.

Includes

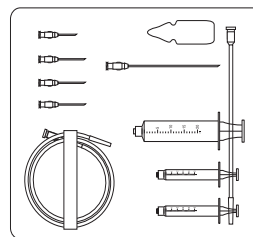

Quantity Description

1	Lidocaine, 1% 5 mL
1	3 Swabsticks Package, PVP Solution
1	Bandage, 0.75" x 3"
2	Syringes 5 mL, L/L
1	Syringe 20 mL, L/L
2	Needles 19 G x 1.5" Filtered
1	Needle 22 G x 1.5"
1	Needle 25 G x.625"
1	Needle, Spinal 22 G x 3.5"
2	Towels, 17" x 19" White
1	Fenestrated Drape w/Adhesive 18" x 26"
5	Sponges, Gauze 3" x 3" (12 Ply)
1	Tubing Set 20" M/F L/S
1	Tubing Set 6" M/F L/S
3	Transport Tubes 10 mL
3	Specimen Labels (White)

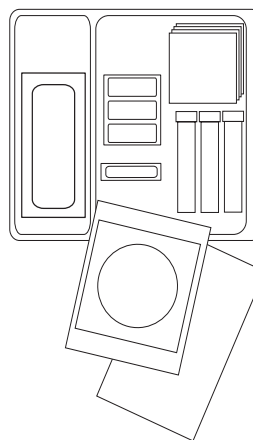

Packaged 10 per case.

Catalog Number K12T-02045

VEIN CLOSURE TRAY

A convenient tray designed to streamline vein closure procedures, improve efficiency, and save money.

Includes

Quantity	Description
1	Band Bag 50" x 50"
1	BD Syringe 5 mL L/L
1	BD Syringe 10 mL L/L
1	BD Syringe 20 mL L/L
1	BD Syringe 3 mL L/L
1	Needle 18G x 1.5"
1	Needle 20G x 1.5"
1	Needle 22G x 1.5"
1	Needle 25G x 1.5"
1	#11 Futura® Safety Scalpel
1	Clear Setup Cover 44" x 77"
1	Skin Marker
1	Bowl 8oz, 250 mL
1	Bowl 16oz, 500 mL
1	Bowl 32oz, 1000 mL
1	Tray 9" x 5" x 2"
1	Probe Cover 6" x 48" w/Gel
1	Steri Strip .5" x 4", 3's
2	Aquasonic Gels 20gm
1	White Polylined Drape 18" x 26"
1	Curved Forceps Mosq. 5"
40	4" x 4" Gauze Pads (12 Ply)
4	Cloth Towels (Blue)
1	XL Shoe Covers (Pair)
2	Towel Clamps
3	Sponge Sticks 6"
1	XL (NRF) Gown
1	Table Cover 44" x 78"
1	Split Drape 77" x 117", 3.5" x 43"
1	Half Drape 44" x 55"
1	Vein Closure Syringe
1	ShortStop Sharps Holder
1	Fluid Administration Set 108" Drip Pack

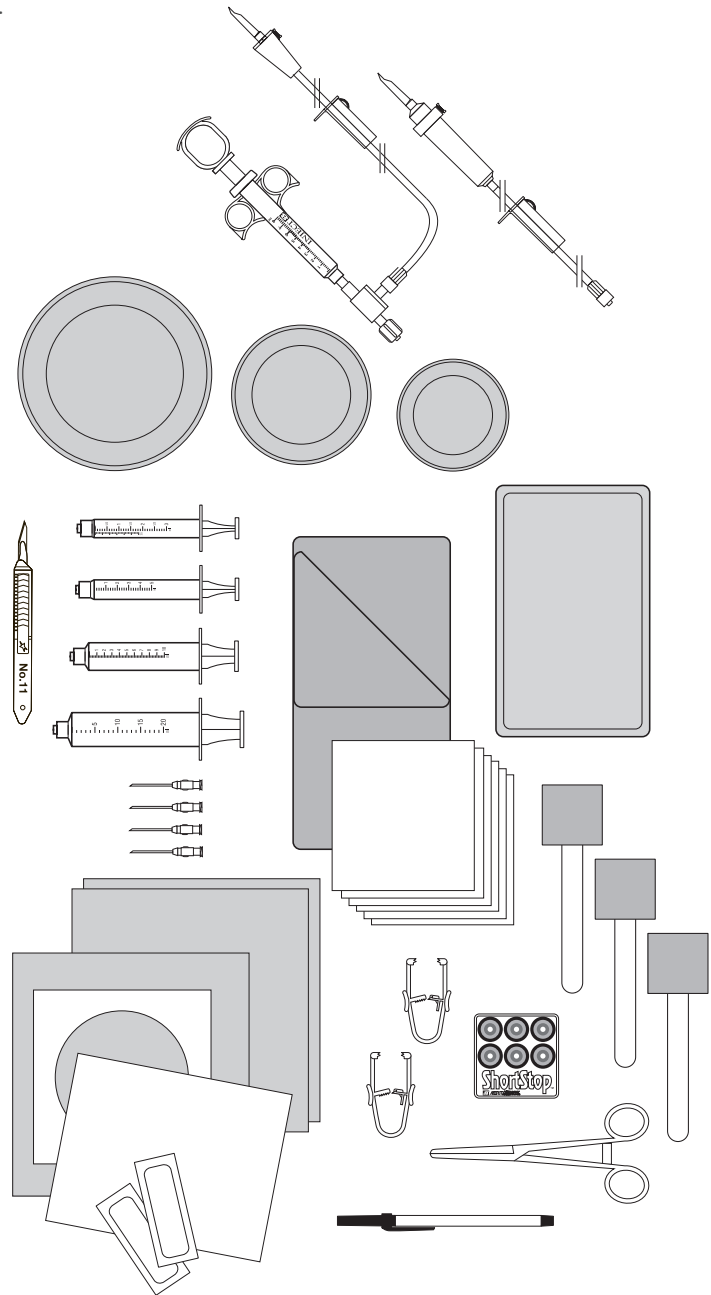

Packaged 3 per case.

Catalog Number K12T-01822

VEIN CLOSURE SYRINGE

This proprietary valved system allows for controlled delivery with less hand fatigue.

Packaged 15 per box, 60 per case.

Catalog Number K12-01575

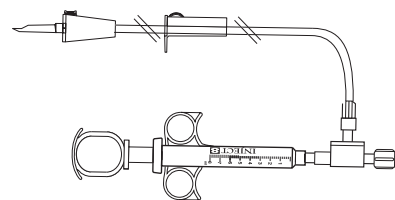

PATIENT COVER

The Patient Cover is a stand alone convenience product that Merit Medical has made available for clinical settings where a fenestrated drape outside of the procedure pack is necessary or desired.

Packaged 10 per case.

Catalog Number K12T-01721

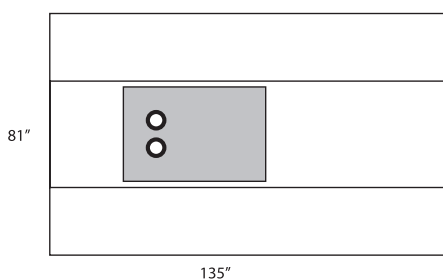

DRAPE ARMOUR® - SCATTER RADIATION DRAPES

These positional protection shields are designed to protect at the procedure site where scatter radiation is most prevalent. They can help protect surgeons and other members of the clinical staff, and offer substantial attenuation as demonstrated by direct beam studies.

Catalog

Number	Description
K12T-07302	16 x 10 Radiation Pad
K12T-07303	16 x 14 Radiation Pad
K12T-07304	16 x 16 Radiation Pad
K12T-07362	16 x 10 Radiation Pad LOW
K12T-07363	16 x 14 Radiation Pad LOW
K12T-07364	16 x 16 Radiation Pad LOW
K12T-07361	16 x 13 x 9 "L" Radiation Pad

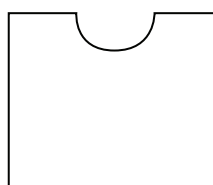
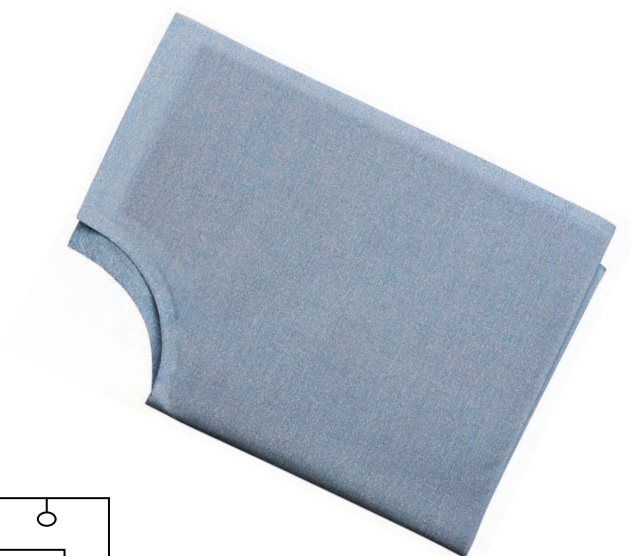

K12T-07302

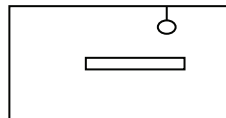

K12T-07303

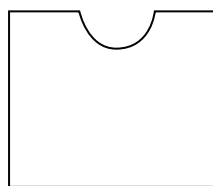

K12T-07362

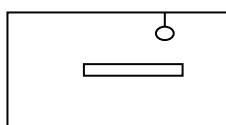

K12T-07363

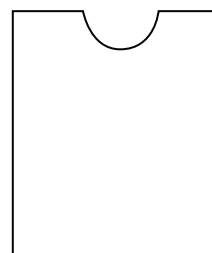

K12T-07304

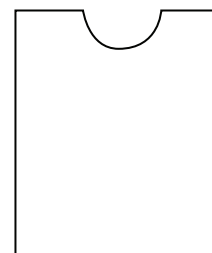

K12T-07364

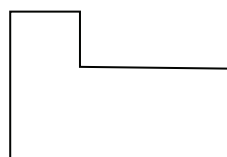

K12T-07361

Drape Armour® is a registered trademark of Microtek Medical, Inc.

MERIT DISPOSAL DEPOT™ WASTE BAGS

Available in many configurations, the Merit Disposal Depot waste bags fully contain fluid waste for easy disposal.

Clear 1400 mL PVC bag, 72" (183 cm) large bore tubing and fixed male luer. Packaged 20 units per box, 4 boxes per case.

Catalog Number MDD100



MDD100

Clear 1400 mL PVC bag, 72" (183 cm) large bore tubing, drape clip and one-way check valve with female luer. Packaged 20 units per box, 4 boxes per case.

Catalog Number MDD110

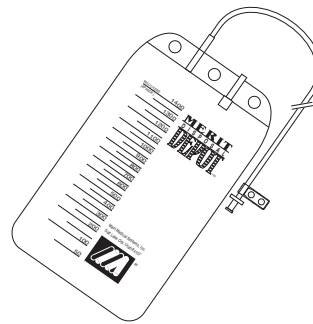

Clear 1400 mL PVC bag, 48" (122 cm) large bore tubing and drape clip. Includes check relief valve with female luer and a fluid administration set with 72" (183 cm) large bore tubing, roller clamp and user selectable vented spike. Packaged 20 units per box, 4 boxes per case.

Catalog Number MDD200
MDD220 (With optional reflux valve)

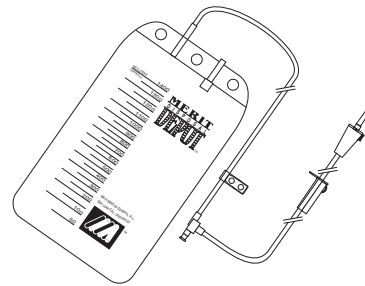

Clear 1400 mL PVC bag, 48" (122 cm) large bore tubing and drape clip. Includes check relief valve with female luer and a fluid administration set with 72" (183 cm) large bore tubing, roller clamp and user selectable vented spike. Packaged 20 units per box, 4 boxes per case.

Catalog Number MDD200H
MDD220H (With optional reflux valve)

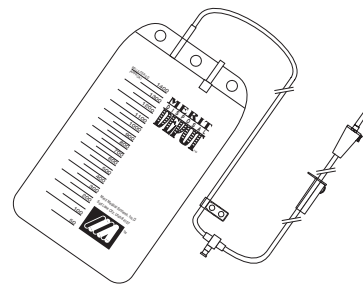

Clear 1400 mL PVC bag and 48" (122 cm) large bore tubing. Includes check relief valve with rotating luer and a fluid administration set with 72" (183 cm) large bore tubing, roller clamp and user-selectable vented spike. Packaged 20 units per box, 4 boxes per case.

Catalog Number MDD300H



MERIT DISPOSAL DEPOT™ WASTE BAGS

Clear 1400 mL PVC bag and 48" (122 cm) large bore tubing. Includes check relief valve with rotating luer and a fluid administration set with 72" (183 cm) small bore tubing, roller clamp and user-selectable vented drip chamber with micro filter. Packaged 20 units per box, 4 boxes per case.

Catalog Number MDD400H



Clear 1400 mL PVC bag, 48" (122 cm) large bore tubing and drape clip. Includes check relief valve with female luer and a fluid administration set with 72" (183 cm) large bore tubing, roller clamp and user selectable vented spike. Packaged 20 units per box, 4 boxes per case.

Catalog Number MDD520H
MDD520H (With optional reflux valve)

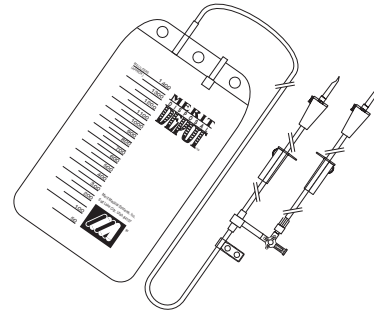

Clear 1400 mL PVC bag, 48" (122 cm) large bore tubing and drape clip. Includes check relief valve, standard pressure 3-way Marquis® Stopcock, one fluid administration set with 72" (183 cm) large bore tubing, roller clamp and user-selectable vented spike. Also includes a bonded Miser® Contrast Management System. Packaged 4 units per box, 4 boxes per case.

Catalog Number K10-00576



K10-00576

MERIT DISPOSAL DEPOT® WASTE BAGS

Clear 1400 mL PVC bag, 48" (122 cm) large bore tubing and drape clip. Includes check relief valve, standard pressure 3-way Marquis® Stopcock one fluid administration set with 72" (183 cm) large bore tubing, roller clamp and user-selectable vented spike. Also includes a bonded In-Line Contrast Management System (CMS). Packaged 8 units per box, 4 boxes per case.

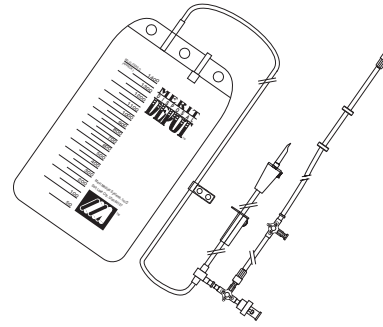

Catalog Number K10-00577

Clear 1400 mL PVC bag, 12" (30.5 cm) bifurcated large bore tubing, (right) 60" (152 cm) large bore tubing with check relief valve and male rotating luer, (left) 60" (152 cm) large bore peel-away tubing with check relief valve, female luer reflux valve and drape clip. Both lines connect to 12" (30.5 cm) large bore FAS line with roller clamp and user-selectable vented spike. Packaged 15 units per box, 4 boxes per case.

Catalog Number K10-01103



K10-01103

Clear 1400 mL PVC bag, 48" (122 cm) large bore tubing and drape clip. Includes check relief valve with female luer and 15" (38 cm) large bore tubing, and fixed male luer. Packaged 20 units per box, 4 boxes per case.

Catalog Number K10-01555

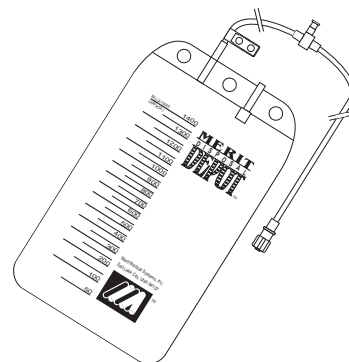

CLO-SUR P.A.D.[®] & CLO-SUR PLUS P.A.D.[™]

Clo-Sur P.A.D. and Clo-Sur^{PLUS} P.A.D. are non-woven topical pads made with a proprietary polyprolate, a positively-charged material that reacts with negatively-charged red blood cells to accelerate clotting. The Clo-Sur P.A.D. promotes haemostasis and the Clo-Sur^{PLUS} P.A.D. promotes haemostasis and is an antimicrobial barrier. 10 units per box.

Catalog Number	Description
MVP44	4x4 cm Scion Clo-Sur PLUS P.A.D.
SCV22P-AB	4x4 cm Antimicrobial Barrier Scion Clo-Sur P.A.D.
HPAD22	Kit with SCV22P-AB and 3M [™] Tegaderm [™] Film*

* 3M and Tegaderm are trademarks of 3M.



SAFEGUARD[®] PRESSURE ASSISTED DEVICE

The SafeGuard pressure assisted device delivers passive compression and enables immediate pressure adjustment. It also maintains consistent pressure on the site when obtaining haemostasis with manual compression, and during patient recovery, positioning and transport. The SafeGuard pressure assisted device reduces demands on the clinical staff, maximises valuable resources, and enhances patient comfort.



Catalog Number	Size	Description
82000	24 cm	SafeGuard Pressure Assisted Device (Outside US)
82000D	24 cm	SafeGuard Pressure Assisted Device (US Only)
82050	12 cm	SafeGuard Pressure Assisted Device
O684-00-0504	24 cm	SafeGuard Pressure Assisted Device (Japan Only)

HAEMOSTASIS VALVE ADAPTER

Minimises blood loss during the introduction of catheters or devices into the vasculature. Provides a side arm and three way stopcock to facilitate aspiration or infusion. May be used with devices that are 8F or smaller. Packaged 10 per box.

Catalog Number HVA-100



CATALOG NUMBER INDEX

61124	INTERVENTION	81	28MC2813045	ANGIOGRAPHY	52
61128	INTERVENTION	81	28MC2813045	EMBOLOTHERAPY	95
61132	INTERVENTION	81	28MC28130SN	ANGIOGRAPHY	52
61136	INTERVENTION	81	28MC28130SN	EMBOLOTHERAPY	95
61140	INTERVENTION	81	28MC28130ST	ANGIOGRAPHY	52
62124	INTERVENTION	81	28MC28130ST	EMBOLOTHERAPY	95
62128	INTERVENTION	81	28MC2815045	ANGIOGRAPHY	52
62132	INTERVENTION	81	28MC2815045	EMBOLOTHERAPY	95
62136	INTERVENTION	81	28MC28150SN	ANGIOGRAPHY	52
62140	INTERVENTION	81	28MC28150SN	EMBOLOTHERAPY	95
63124	INTERVENTION	81	28MC28150ST	ANGIOGRAPHY	52
63128	INTERVENTION	81	28MC28150ST	EMBOLOTHERAPY	95
63132	INTERVENTION	81	29MC2911045	ANGIOGRAPHY	52
63136	INTERVENTION	81	29MC2911045	EMBOLOTHERAPY	95
63140	INTERVENTION	81	29MC29110SN	ANGIOGRAPHY	52
64124	INTERVENTION	81	29MC29110SN	EMBOLOTHERAPY	95
64128	INTERVENTION	81	29MC29110ST	ANGIOGRAPHY	52
64132	INTERVENTION	81	29MC29110ST	EMBOLOTHERAPY	95
64136	INTERVENTION	81	29MC2913045	ANGIOGRAPHY	52
64140	INTERVENTION	81	29MC2913045	EMBOLOTHERAPY	95
82000	CPS	109	29MC29130SN	ANGIOGRAPHY	52
82050	CPS	109	29MC29130SN	EMBOLOTHERAPY	95
28MC2411045	ANGIOGRAPHY	52	29MC29130ST	ANGIOGRAPHY	52
28MC2411045	EMBOLOTHERAPY	95	29MC29130ST	EMBOLOTHERAPY	95
28MC24110SN	ANGIOGRAPHY	52	29MC2915045	ANGIOGRAPHY	52
28MC24110SN	EMBOLOTHERAPY	95	29MC2915045	EMBOLOTHERAPY	95
28MC24110ST	ANGIOGRAPHY	52	29MC29150SN	ANGIOGRAPHY	52
28MC24110ST	EMBOLOTHERAPY	95	29MC29150SN	EMBOLOTHERAPY	95
28MC2413045	ANGIOGRAPHY	52	29MC29150ST	ANGIOGRAPHY	52
28MC2413045	EMBOLOTHERAPY	95	29MC29150ST	EMBOLOTHERAPY	95
28MC24130SN	ANGIOGRAPHY	52	3339-21	ACCESS	7
28MC24130SN	EMBOLOTHERAPY	95	3339-31	ACCESS	7
28MC24130ST	ANGIOGRAPHY	52	3339-41	ACCESS	7
28MC24130ST	EMBOLOTHERAPY	95	3339-51	ACCESS	7
28MC2415045	ANGIOGRAPHY	52	410035B1	ANGIOGRAPHY	24
28MC2415045	EMBOLOTHERAPY	95	410035B2	ANGIOGRAPHY	24
28MC24150SN	ANGIOGRAPHY	52	410035BER	ANGIOGRAPHY	25
28MC24150SN	EMBOLOTHERAPY	95	410035HH1	ANGIOGRAPHY	23
28MC24150ST	ANGIOGRAPHY	52	410035HH3	ANGIOGRAPHY	23
28MC24150ST	EMBOLOTHERAPY	95	410035MANI	ANGIOGRAPHY	24
28MC2811045	ANGIOGRAPHY	52	410035MC	ANGIOGRAPHY	24
28MC2811045	EMBOLOTHERAPY	95	410035MOT	ANGIOGRAPHY	27
28MC28110SN	ANGIOGRAPHY	52	410035MOTC	ANGIOGRAPHY	27
28MC28110SN	EMBOLOTHERAPY	95	410035OSB1	ANGIOGRAPHY	30
28MC28110ST	ANGIOGRAPHY	52	410035SIM1	ANGIOGRAPHY	25
28MC28110ST	EMBOLOTHERAPY	95	410035SIM2	ANGIOGRAPHY	25

410035VER	ANGIOGRAPHY	24	44038KA2-H	ANGIOGRAPHY	34
410038B1	ANGIOGRAPHY	24	44038MW2	ANGIOGRAPHY	25
410038B1-H	ANGIOGRAPHY	33	4653510PIG-NB	ANGIOGRAPHY	31
410038B2-H	ANGIOGRAPHY	33	4653510STF-NB	ANGIOGRAPHY	32
410038BER	ANGIOGRAPHY	25	4653510UBF-NB	ANGIOGRAPHY	31
410038BER-H	ANGIOGRAPHY	33	465352CB1	ANGIOGRAPHY	26
410038CB1	ANGIOGRAPHY	26	465352CB2	ANGIOGRAPHY	26
410038CB2	ANGIOGRAPHY	26	465352HK0-8	ANGIOGRAPHY	26
410038CB2-H	ANGIOGRAPHY	33	465352HK1-0	ANGIOGRAPHY	26
410038HH1	ANGIOGRAPHY	23	465352RC	ANGIOGRAPHY	27
410038HH1-H	ANGIOGRAPHY	34	465352SH0-8	ANGIOGRAPHY	27
410038HH3	ANGIOGRAPHY	23	465352SH1-0	ANGIOGRAPHY	27
410038HS	ANGIOGRAPHY	28	465354RBI	ANGIOGRAPHY	29
410038MANI	ANGIOGRAPHY	24	465356MHK-NB	ANGIOGRAPHY	32
410038MANI-H	ANGIOGRAPHY	34	465356SHP-NB	ANGIOGRAPHY	30
410038MC	ANGIOGRAPHY	24	46535AVS20MHK	ANGIOGRAPHY	50
410038MPA1	ANGIOGRAPHY	30	46535B1	ANGIOGRAPHY	24
410038MPA1-H	ANGIOGRAPHY	34	46535BER	ANGIOGRAPHY	25
410038N1	ANGIOGRAPHY	23	46535CB2	ANGIOGRAPHY	26
410038N2	ANGIOGRAPHY	23	46535MOT	ANGIOGRAPHY	27
410038N3	ANGIOGRAPHY	23	46535MOTC	ANGIOGRAPHY	27
410038N4	ANGIOGRAPHY	23	46535RC	ANGIOGRAPHY	27
410038SIM1	ANGIOGRAPHY	25	46535RIM	ANGIOGRAPHY	29
410038SIM1-H	ANGIOGRAPHY	35	46535SIM1	ANGIOGRAPHY	25
410038SIM2	ANGIOGRAPHY	25	4653810MUBF-NB	ANGIOGRAPHY	31
410038SIM2-H	ANGIOGRAPHY	35	465382CB1	ANGIOGRAPHY	26
410038STS-H	ANGIOGRAPHY	36	465382CB2	ANGIOGRAPHY	26
410038VER	ANGIOGRAPHY	24	46538BER	ANGIOGRAPHY	25
410038VER-H	ANGIOGRAPHY	36	46538BER-H	ANGIOGRAPHY	33
41103510PIG-NB	ANGIOGRAPHY	31	46538CB1	ANGIOGRAPHY	26
411035STS	ANGIOGRAPHY	29	46538CB1-H	ANGIOGRAPHY	33
411038STS	ANGIOGRAPHY	29	46538CB2	ANGIOGRAPHY	26
412535HH1	ANGIOGRAPHY	23	46538CB2-H	ANGIOGRAPHY	33
412535VER	ANGIOGRAPHY	24	46538KA2	ANGIOGRAPHY	28
412538BER	ANGIOGRAPHY	25	46538KA2-H	ANGIOGRAPHY	34
412538BER-H	ANGIOGRAPHY	33	46538SIM1	ANGIOGRAPHY	25
412538HH1-H	ANGIOGRAPHY	34	46538SIM2	ANGIOGRAPHY	25
412538MPA1	ANGIOGRAPHY	30	46538STS	ANGIOGRAPHY	29
412538STS-H	ANGIOGRAPHY	36	46538STS-H	ANGIOGRAPHY	36
4303510PIG-NB	ANGIOGRAPHY	30	46538VER	ANGIOGRAPHY	24
4303510PIG-NB	ANGIOGRAPHY	31	46538VER-H	ANGIOGRAPHY	36
4303510PIG-NB	INTERVENTION	79	48035MHK1	ANGIOGRAPHY	29
43035BER	ANGIOGRAPHY	30	48035MHK2	ANGIOGRAPHY	29
43035BER	INTERVENTION	79	48035MHK3	ANGIOGRAPHY	29
43035KA2	ANGIOGRAPHY	30	48035MODS	ANGIOGRAPHY	25
43035KA2	INTERVENTION	79	48038MHK1-H	ANGIOGRAPHY	35
43035MODCB1	ANGIOGRAPHY	30	48038MHK2-H	ANGIOGRAPHY	35
43035MODCB1	INTERVENTION	79	48038MHK3-H	ANGIOGRAPHY	35
43035RIM	ANGIOGRAPHY	30	48038MIK	ANGIOGRAPHY	28
43035RIM	INTERVENTION	79	48038MODS	ANGIOGRAPHY	25
43035STR	ANGIOGRAPHY	30	48038RE	ANGIOGRAPHY	28
43035STR	INTERVENTION	79	4903510PIG-NB	ANGIOGRAPHY	31
44035STS	ANGIOGRAPHY	29	4903510STF-NB	ANGIOGRAPHY	32
44038KA2	ANGIOGRAPHY	28	4903510UBF-NB	ANGIOGRAPHY	31

490356MHK-NB	ANGIOGRAPHY	32	512538BER	ANGIOGRAPHY	25
490356SHP-NB	ANGIOGRAPHY	30	512538BER-H	ANGIOGRAPHY	33
5100354RBI	ANGIOGRAPHY	29	512538HH1	ANGIOGRAPHY	23
510035AVS20MHK	ANGIOGRAPHY	50	512538HH1-H	ANGIOGRAPHY	34
510035AVS20PIG	ANGIOGRAPHY	50	512538MPA1	ANGIOGRAPHY	30
510035AVS2MHK	ANGIOGRAPHY	50	5303510PIG-NB	ANGIOGRAPHY	30
510035AVS2PIG	ANGIOGRAPHY	50	5303510PIG-NB	ANGIOGRAPHY	31
510035AVS2STR	ANGIOGRAPHY	50	5303510PIG-NB	INTERVENTION	79
510035B1	ANGIOGRAPHY	24	53035BER	ANGIOGRAPHY	30
510035B2	ANGIOGRAPHY	24	53035BER	INTERVENTION	79
510035BER	ANGIOGRAPHY	25	53035KA2	ANGIOGRAPHY	30
510035HH1	ANGIOGRAPHY	23	53035KA2	INTERVENTION	79
510035HH3	ANGIOGRAPHY	23	53035MODCB1	ANGIOGRAPHY	30
510035MANI	ANGIOGRAPHY	24	53035MODCB1	INTERVENTION	79
510035MC	ANGIOGRAPHY	24	53035RIM	ANGIOGRAPHY	30
510035MOT	ANGIOGRAPHY	27	53035RIM	INTERVENTION	79
510035OSB1	ANGIOGRAPHY	30	53035STR	ANGIOGRAPHY	30
510035RBI	ANGIOGRAPHY	29	53035STR	INTERVENTION	79
510035SIM1	ANGIOGRAPHY	25	54038KA2	ANGIOGRAPHY	28
510035SIM2	ANGIOGRAPHY	25	54038KA2-H	ANGIOGRAPHY	34
510035VER	ANGIOGRAPHY	24	54038STS	ANGIOGRAPHY	29
510038B1	ANGIOGRAPHY	24	5575-13	ANGIOGRAPHY	37
510038B1-H	ANGIOGRAPHY	33	5575-23	ANGIOGRAPHY	37
510038B2-H	ANGIOGRAPHY	33	5575-33	ANGIOGRAPHY	37
510038BER	ANGIOGRAPHY	25	5575-43	ANGIOGRAPHY	37
510038BER-H	ANGIOGRAPHY	33	5575-A3	ANGIOGRAPHY	37
510038CB1	ANGIOGRAPHY	26	5575-B3	ANGIOGRAPHY	37
510038CB2	ANGIOGRAPHY	26	5575-C3	ANGIOGRAPHY	37
510038CB2-H	ANGIOGRAPHY	33	5575-D3	ANGIOGRAPHY	37
510038HH1	ANGIOGRAPHY	23	5576-13	ANGIOGRAPHY	42
510038HH1-H	ANGIOGRAPHY	34	5576-23	ANGIOGRAPHY	42
510038HH3	ANGIOGRAPHY	23	5576-33	ANGIOGRAPHY	42
510038HS	ANGIOGRAPHY	28	5576-43	ANGIOGRAPHY	42
510038MANI	ANGIOGRAPHY	24	5576-A3	ANGIOGRAPHY	42
510038MANI-H	ANGIOGRAPHY	34	5576-B3	ANGIOGRAPHY	42
510038MC	ANGIOGRAPHY	24	5576-C3	ANGIOGRAPHY	42
510038MPA1	ANGIOGRAPHY	30	5576-D3	ANGIOGRAPHY	42
510038MPA1-H	ANGIOGRAPHY	34	5576-E3	ANGIOGRAPHY	42
510038N1	ANGIOGRAPHY	23	5576-F3	ANGIOGRAPHY	42
510038N2	ANGIOGRAPHY	23	5576-G3	ANGIOGRAPHY	42
510038N3	ANGIOGRAPHY	23	5577-13	ANGIOGRAPHY	38
510038N4	ANGIOGRAPHY	23	5577-23	ANGIOGRAPHY	38
510038SIM1	ANGIOGRAPHY	25	5577-33	ANGIOGRAPHY	38
510038SIM1-H	ANGIOGRAPHY	35	5577-43	ANGIOGRAPHY	38
510038SIM2	ANGIOGRAPHY	25	5577-53	ANGIOGRAPHY	38
510038SIM2-H	ANGIOGRAPHY	35	5577-A3	ANGIOGRAPHY	38
510038STS-H	ANGIOGRAPHY	36	5577-B3	ANGIOGRAPHY	38
510038VER	ANGIOGRAPHY	24	5577-C3	ANGIOGRAPHY	38
510038VER-H	ANGIOGRAPHY	36	5577-D3	ANGIOGRAPHY	38
51103510PIG-NB	ANGIOGRAPHY	31	5577-E3	ANGIOGRAPHY	38
511035STS	ANGIOGRAPHY	29	5578-13	ANGIOGRAPHY	39
51103810PIG-NB	ANGIOGRAPHY	31	5578-23	ANGIOGRAPHY	39
511038STS	ANGIOGRAPHY	29	5578-33	ANGIOGRAPHY	39
512535HH1	ANGIOGRAPHY	23	5578-A3	ANGIOGRAPHY	39
512535VER	ANGIOGRAPHY	24	5578-B3	ANGIOGRAPHY	39

5578-C3	ANGIOGRAPHY	39
5579-13	ANGIOGRAPHY	39
5579-A3	ANGIOGRAPHY	39
5582-13	ANGIOGRAPHY	46
5582-23	ANGIOGRAPHY	46
5582-33	ANGIOGRAPHY	46
5582-43	ANGIOGRAPHY	46
5583-13	ANGIOGRAPHY	39
5583-23	ANGIOGRAPHY	39
5583-A3	ANGIOGRAPHY	39
5583-B3	ANGIOGRAPHY	39
5584-13	ANGIOGRAPHY	43
5584-23	ANGIOGRAPHY	43
5584-33	ANGIOGRAPHY	43
5584-43	ANGIOGRAPHY	43
5584-53	ANGIOGRAPHY	43
5584-63	ANGIOGRAPHY	43
5584-A3	ANGIOGRAPHY	43
5584-B3	ANGIOGRAPHY	43
5584-C3	ANGIOGRAPHY	43
5584-D3	ANGIOGRAPHY	43
5584-E3	ANGIOGRAPHY	43
5584-F3	ANGIOGRAPHY	43
5585-13	ANGIOGRAPHY	41
5585-23	ANGIOGRAPHY	41
5585-A3	ANGIOGRAPHY	41
5585-B3	ANGIOGRAPHY	41
5585-C3	ANGIOGRAPHY	42
5585-D3	ANGIOGRAPHY	42
5585-E3	ANGIOGRAPHY	42
5586-13	ANGIOGRAPHY	44
5586-23	ANGIOGRAPHY	44
5586-43	ANGIOGRAPHY	44
5586-A3	ANGIOGRAPHY	44
5586-B3	ANGIOGRAPHY	44
5587-13	ANGIOGRAPHY	44
5587-23	ANGIOGRAPHY	44
5587-A3	ANGIOGRAPHY	44
5588-13	ANGIOGRAPHY	40
5588-A3	ANGIOGRAPHY	40
5589-13	ANGIOGRAPHY	45
5589-23	ANGIOGRAPHY	45
5589-A3	ANGIOGRAPHY	45
5589-B3	ANGIOGRAPHY	45
5590-13	ANGIOGRAPHY	41
5590-23	ANGIOGRAPHY	41
5590-33	ANGIOGRAPHY	41
5591-A3	ANGIOGRAPHY	45
5591-B3	ANGIOGRAPHY	45
5591-C3	ANGIOGRAPHY	45
5591-D3	ANGIOGRAPHY	45
5591-E3	ANGIOGRAPHY	45
5591-F3	ANGIOGRAPHY	45
5592-13	ANGIOGRAPHY	40
5592-23	ANGIOGRAPHY	40

5592-33	ANGIOGRAPHY	40
5592-A3	ANGIOGRAPHY	40
5592-B3	ANGIOGRAPHY	40
5592-C3	ANGIOGRAPHY	40
5594-13	ANGIOGRAPHY	46
5595-13	ANGIOGRAPHY	46
5595-23	ANGIOGRAPHY	46
5595-33	ANGIOGRAPHY	46
5595-43	ANGIOGRAPHY	46
5595-A3	ANGIOGRAPHY	46
5595-B3	ANGIOGRAPHY	46
5595-C3	ANGIOGRAPHY	46
5595-D3	ANGIOGRAPHY	46
5653510PIG-NB	ANGIOGRAPHY	31
5653510STF-NB	ANGIOGRAPHY	32
5653510UBF-NB	ANGIOGRAPHY	31
565352CB1	ANGIOGRAPHY	26
565352CB2	ANGIOGRAPHY	26
565352HK0-8	ANGIOGRAPHY	26
565352HK1-0	ANGIOGRAPHY	26
565352RC	ANGIOGRAPHY	27
565352SH0-8	ANGIOGRAPHY	27
565352SH1-0	ANGIOGRAPHY	27
565354RBI	ANGIOGRAPHY	29
565356SHP-NB	ANGIOGRAPHY	30
56535AVS20MHK	ANGIOGRAPHY	50
56535AVS20PIG	ANGIOGRAPHY	50
56535AVS2MHK	ANGIOGRAPHY	50
56535AVS2PIG	ANGIOGRAPHY	50
56535AVS2STR	ANGIOGRAPHY	50
56535B1	ANGIOGRAPHY	24
56535BER	ANGIOGRAPHY	25
56535MOT	ANGIOGRAPHY	27
56535MRIMST	ANGIOGRAPHY	29
56535RBI	ANGIOGRAPHY	29
56535RIM	ANGIOGRAPHY	29
56535SIM1	ANGIOGRAPHY	25
5653810MUBF-NB	ANGIOGRAPHY	31
5653810PIG-NB	ANGIOGRAPHY	31
565382CB1	ANGIOGRAPHY	26
565382CB2	ANGIOGRAPHY	26
56538BER	ANGIOGRAPHY	25
56538BER-H	ANGIOGRAPHY	33
56538CB1	ANGIOGRAPHY	26
56538CB1-H	ANGIOGRAPHY	33
56538CB2	ANGIOGRAPHY	26
56538CB2-H	ANGIOGRAPHY	33
56538KA2	ANGIOGRAPHY	28
56538KA2-H	ANGIOGRAPHY	34
56538MPA1	ANGIOGRAPHY	30
56538MW2	ANGIOGRAPHY	25
56538RBI-H	ANGIOGRAPHY	35
56538SIM1	ANGIOGRAPHY	25
56538SIM2	ANGIOGRAPHY	25
56538STS	ANGIOGRAPHY	29

56538STS-H	ANGIOGRAPHY	36
56538VER	ANGIOGRAPHY	24
56538VER-H	ANGIOGRAPHY	36
58035MHK1	ANGIOGRAPHY	29
58035MHK2	ANGIOGRAPHY	29
58035MHK3	ANGIOGRAPHY	29
58035RE	ANGIOGRAPHY	28
58038MHK1-H	ANGIOGRAPHY	35
58038MHK2-H	ANGIOGRAPHY	35
58038MHK3-H	ANGIOGRAPHY	35
58038MIK	ANGIOGRAPHY	28
58038RE	ANGIOGRAPHY	28
5903510PIG-NB	ANGIOGRAPHY	31
5903510STF-NB	ANGIOGRAPHY	32
5903510UBF-NB	ANGIOGRAPHY	31
5903810PIG-NB	ANGIOGRAPHY	31
59038UAC	ANGIOGRAPHY	28
59038UAC	EMBOLOTHERAPY	96
6609-33	ANGIOGRAPHY	13
6647-11	ANGIOGRAPHY	14
6676-A1	ANGIOGRAPHY	13
6676-B3	ANGIOGRAPHY	13
6676-C1	ANGIOGRAPHY	13
6676-D3	ANGIOGRAPHY	13
6677-B1	ANGIOGRAPHY	13
6680-11	ANGIOGRAPHY	13
6680-23	ANGIOGRAPHY	13
6680-31	ANGIOGRAPHY	13
6680-43	ANGIOGRAPHY	13
6680-51	ANGIOGRAPHY	13
6680-61	ANGIOGRAPHY	13
6680-71	ANGIOGRAPHY	13
6682-E1	ANGIOGRAPHY	14
6682-K1	ANGIOGRAPHY	14
6682-L3	ANGIOGRAPHY	14
6682-M1	ANGIOGRAPHY	14
6682-N3	ANGIOGRAPHY	14
6684-61	ANGIOGRAPHY	14
6690-41	ANGIOGRAPHY	13
6690-61	ANGIOGRAPHY	13
6693-41	ANGIOGRAPHY	14
6693-61	ANGIOGRAPHY	14
6693-71	ANGIOGRAPHY	14
6693-A1	ANGIOGRAPHY	14
6694-21	ANGIOGRAPHY	14
680ME	INTERVENTION	68
685ME	INTERVENTION	68
7514-13	ANGIOGRAPHY	46
7514-23	ANGIOGRAPHY	46
7541-13	ANGIOGRAPHY	44
7543-13	ANGIOGRAPHY	44
7602-11M	ANGIOGRAPHY	49
7602-11M65	ANGIOGRAPHY	49
7602-20M	ANGIOGRAPHY	49
7602-20M100SH	ANGIOGRAPHY	49

7602-20M65	ANGIOGRAPHY	49
7602-20M65SH	ANGIOGRAPHY	49
7602-2M	ANGIOGRAPHY	49
7602-2M65	ANGIOGRAPHY	49
7602-41	ANGIOGRAPHY	47
7602-51	ANGIOGRAPHY	47
7602-61	ANGIOGRAPHY	47
7602-71	ANGIOGRAPHY	47
7602-81	ANGIOGRAPHY	47
7602-91	ANGIOGRAPHY	47
7602-A1	ANGIOGRAPHY	47
7602-B1	ANGIOGRAPHY	47
7602-C1	ANGIOGRAPHY	47
7602-D1	ANGIOGRAPHY	47
7603-11M100	ANGIOGRAPHY	49
7603-11M65	ANGIOGRAPHY	49
7603-20M100SH	ANGIOGRAPHY	49
7603-20M65SH	ANGIOGRAPHY	49
7603-2M100	ANGIOGRAPHY	49
7603-2M65	ANGIOGRAPHY	49
7603-A1	ANGIOGRAPHY	48
7603-B1	ANGIOGRAPHY	48
7603-C1	ANGIOGRAPHY	48
7603-D1	ANGIOGRAPHY	48
7673-11	ANGIOGRAPHY	48
7673-11M100SH	ANGIOGRAPHY	49
7673-11M65SH	ANGIOGRAPHY	49
7673-20M100SH	ANGIOGRAPHY	49
7673-20M65SH	ANGIOGRAPHY	49
7673-21	ANGIOGRAPHY	48
7673-2M	ANGIOGRAPHY	49
7673-2M65	ANGIOGRAPHY	49
7673-31	ANGIOGRAPHY	48
7673-41	ANGIOGRAPHY	48
7673-51	ANGIOGRAPHY	48
7673-61	ANGIOGRAPHY	48
7674-11	ANGIOGRAPHY	47
7674-21	ANGIOGRAPHY	47
7674-2M	ANGIOGRAPHY	49
7674-2M65	ANGIOGRAPHY	49
7674-31	ANGIOGRAPHY	47
7674-41	ANGIOGRAPHY	47
7674-41	ANGIOGRAPHY	47
7710-10	ANGIOGRAPHY	43
7710-20	ANGIOGRAPHY	43
7710-30	ANGIOGRAPHY	43
7710-40	ANGIOGRAPHY	43
7710-50	ANGIOGRAPHY	43
7710-60	ANGIOGRAPHY	43
7710-A0	ANGIOGRAPHY	43
7710-B0	ANGIOGRAPHY	43
7710-C0	ANGIOGRAPHY	43
7710-D0	ANGIOGRAPHY	43
7710-E0	ANGIOGRAPHY	43
7710-F0	ANGIOGRAPHY	43
7711-10	ANGIOGRAPHY	41

7711-20	ANGIOGRAPHY	41
7711-A0	ANGIOGRAPHY	41
7711-B0	ANGIOGRAPHY	41
7712-10	ANGIOGRAPHY	44
7712-20	ANGIOGRAPHY	44
7712-30	ANGIOGRAPHY	44
7712-40	ANGIOGRAPHY	44
7712-A0	ANGIOGRAPHY	44
7712-B0	ANGIOGRAPHY	44
7712-C0	ANGIOGRAPHY	44
7712-D0	ANGIOGRAPHY	44
7713-10	ANGIOGRAPHY	44
7713-20	ANGIOGRAPHY	44
7713-A0	ANGIOGRAPHY	44
7713-B0	ANGIOGRAPHY	44
7714-10	ANGIOGRAPHY	45
7714-20	ANGIOGRAPHY	45
7714-A0	ANGIOGRAPHY	45
7714-B0	ANGIOGRAPHY	45
7715-10	ANGIOGRAPHY	37
7715-30	ANGIOGRAPHY	37
7715-50	ANGIOGRAPHY	37
7715-60	ANGIOGRAPHY	37
7715-A0	ANGIOGRAPHY	37
7715-B0	ANGIOGRAPHY	37
7715-C0	ANGIOGRAPHY	37
7715-D0	ANGIOGRAPHY	37
7716-10	ANGIOGRAPHY	39
7716-A0	ANGIOGRAPHY	39
7717-10	ANGIOGRAPHY	39
7717-20	ANGIOGRAPHY	39
7717-30	ANGIOGRAPHY	39
7717-A0	ANGIOGRAPHY	39
7717-B0	ANGIOGRAPHY	39
7717-C0	ANGIOGRAPHY	39
7718-10	ANGIOGRAPHY	40
7718-20	ANGIOGRAPHY	40
7718-30	ANGIOGRAPHY	40
7718-A0	ANGIOGRAPHY	40
7718-B0	ANGIOGRAPHY	40
7718-C0	ANGIOGRAPHY	40
7719-10	ANGIOGRAPHY	46
7719-A0	ANGIOGRAPHY	46
7720-10	ANGIOGRAPHY	42
7720-20	ANGIOGRAPHY	42
7720-30	ANGIOGRAPHY	42
7720-40	ANGIOGRAPHY	42
7720-53	ANGIOGRAPHY	42
7720-70	ANGIOGRAPHY	42
7720-80	ANGIOGRAPHY	42
7720-A0	ANGIOGRAPHY	42
7720-B0	ANGIOGRAPHY	42
7720-C0	ANGIOGRAPHY	42
7720-D0	ANGIOGRAPHY	42
7720-E0	ANGIOGRAPHY	42

7720-F0	ANGIOGRAPHY	42
7721-10	ANGIOGRAPHY	39
7721-20	ANGIOGRAPHY	39
7721-30	ANGIOGRAPHY	39
7721-A0	ANGIOGRAPHY	39
7721-B0	ANGIOGRAPHY	39
7721-C0	ANGIOGRAPHY	39
7722-10	ANGIOGRAPHY	38
7722-20	ANGIOGRAPHY	38
7722-30	ANGIOGRAPHY	38
7722-40	ANGIOGRAPHY	38
7722-50	ANGIOGRAPHY	38
7722-A0	ANGIOGRAPHY	38
7722-B0	ANGIOGRAPHY	38
7722-C0	ANGIOGRAPHY	38
7722-D0	ANGIOGRAPHY	38
7722-E0	ANGIOGRAPHY	38
7723-10	ANGIOGRAPHY	40
7723-A0	ANGIOGRAPHY	40
7742-20M100SH	ANGIOGRAPHY	49
7742-20M65SH	ANGIOGRAPHY	49
7742-2M100SH	ANGIOGRAPHY	49
7742-2M65SH	ANGIOGRAPHY	49
7743-2M100SH	ANGIOGRAPHY	49
7743-2M65SH	ANGIOGRAPHY	49
7744-2M100SH	ANGIOGRAPHY	49
7744-2M65SH	ANGIOGRAPHY	49
7745-10	ANGIOGRAPHY	41
7745-B0	ANGIOGRAPHY	41
7745-C0	ANGIOGRAPHY	41
7746-10	ANGIOGRAPHY	41
7746-20	ANGIOGRAPHY	41
7746-30	ANGIOGRAPHY	41
7746-A0	ANGIOGRAPHY	41
7746-B0	ANGIOGRAPHY	41
7746-C0	ANGIOGRAPHY	41
7747-10	ANGIOGRAPHY	45
7747-20	ANGIOGRAPHY	45
7747-A0	ANGIOGRAPHY	45
7747-B0	ANGIOGRAPHY	45
7747-C0	ANGIOGRAPHY	45
7747-D0	ANGIOGRAPHY	45
7747-E0	ANGIOGRAPHY	45
7747-F0	ANGIOGRAPHY	45
7748-13	ANGIOGRAPHY	40
7748-A0	ANGIOGRAPHY	40
7749-A0	ANGIOGRAPHY	47
7752-10	ANGIOGRAPHY	44
7755-2M100	ANGIOGRAPHY	49
7755-2M65	ANGIOGRAPHY	49
82000D	CPS	109
8820-B1	ANGIOGRAPHY	14
AD18N91W	ACCESS	3
AD18T51W	ACCESS	3
AD18T51WS	ACCESS	3

AD18T71W	ACCESS	3	CENF23C	INTERVENTION	80
AD18T71WC	ACCESS	3	CENF23K	INTERVENTION	80
AD18T71W-E	ACCESS	3	CENF27C	INTERVENTION	80
AD18T71WS	ACCESS	3	CENF27K	INTERVENTION	80
AD18T71WT	ACCESS	3	CENF31C	INTERVENTION	80
AD19U41W	ACCESS	3	CENF31K	INTERVENTION	80
AD19U41WC	ACCESS	3	CET100	INTERVENTION	83
AD19U51W	ACCESS	3	CET200	INTERVENTION	83
AD19U71W	ACCESS	3	CET300	INTERVENTION	83
AD19U71WC	ACCESS	3	CF-4230	INTERVENTION	83
AD19U71WS	ACCESS	3	CF-4235	INTERVENTION	83
AD20T41W	ACCESS	3	CF-4430	INTERVENTION	83
AD20T71W	ACCESS	3	CF-5161	INTERVENTION	83
AD21T21W	ACCESS	3	CF-5242	INTERVENTION	83
AD21T21W	ACCESS	7	CF-5243	INTERVENTION	83
AD21T41W	ACCESS	3	CF-5244	INTERVENTION	83
AD21T41W	ACCESS	7	CF-5247	INTERVENTION	83
AD21T41WC	ACCESS	3	CF-5249	INTERVENTION	83
AD21T41W-E	ACCESS	3	CF-5250	INTERVENTION	83
AD21T41W-E	ACCESS	7	CF-5260	INTERVENTION	83
AD21T71W	ACCESS	3	CF-5270	INTERVENTION	83
AD21T71W	ACCESS	7	CF-5442	INTERVENTION	83
AD21T71W-E	ACCESS	3	CF-5443	INTERVENTION	83
AD21T71W-E	ACCESS	7	CF-5450	INTERVENTION	83
AD21T91R	ACCESS	3	CF-5460	INTERVENTION	83
AD21T91R	INTERVENTION	77	CF-5470	INTERVENTION	83
AD21T91RE	ACCESS	3	CF-5560	INTERVENTION	83
AD21T91RE	INTERVENTION	77	CFG624	INTERVENTION	68
AD21T91W	ACCESS	3	CS-242	INTERVENTION	84
AD21T91W	ACCESS	7	CS-352	INTERVENTION	84
AD21T91W-E	ACCESS	3	CS-362	INTERVENTION	84
AD21T91W-E	ACCESS	7	DC01452419	INTERVENTION	82
ASK200	ACCESS	10	DC01452419-NE5	INTERVENTION	82
BT101	ACCESS	10	DC01452823	INTERVENTION	82
CC-1301	INTERVENTION	84	DC01452823-NE5	INTERVENTION	82
CC-1360	INTERVENTION	84	DC01453227	INTERVENTION	82
CC-2300	INTERVENTION	84	DC01453227-NE5	INTERVENTION	82
CE-1400	INTERVENTION	84	DC01453631	INTERVENTION	82
CEN15C	INTERVENTION	80	DC01454035	INTERVENTION	82
CEN15K	INTERVENTION	80	DC01455550	INTERVENTION	82
CEN17C	INTERVENTION	80	DC21452419	INTERVENTION	82
CEN17K	INTERVENTION	80	DC21452419-NE5	INTERVENTION	82
CEN19C	INTERVENTION	80	DC21452823	INTERVENTION	82
CEN19K	INTERVENTION	80	DC21452823-NE5	INTERVENTION	82
CEN23C	INTERVENTION	80	DC21453227	INTERVENTION	82
CEN23K	INTERVENTION	80	DC21453227-NE5	INTERVENTION	82
CEN27C	INTERVENTION	80	DC21453631	INTERVENTION	82
CEN27K	INTERVENTION	80	DC21454035	INTERVENTION	82
CEN31C	INTERVENTION	80	DC21455550	INTERVENTION	82
CEN31K	INTERVENTION	80	EN1003008	INTERVENTION	75
CENF15C	INTERVENTION	80	EN2006010	INTERVENTION	75
CENF17C	INTERVENTION	80	EN2006015	INTERVENTION	75
CENF17K	INTERVENTION	80	EN2006020	INTERVENTION	75
CENF19C	INTERVENTION	80	EN2007030	INTERVENTION	75
CENF19K	INTERVENTION	80	EN2007045	INTERVENTION	75

ENDO-AN6012	INTERVENTION	74
FAS5248	INTERVENTION	71
FDS100	INTERVENTION	89
FIS4-135-10	INTERVENTION	86
FIS4-135-10SQ	INTERVENTION	86
FIS4-135-20	INTERVENTION	86
FIS4-135-20SQ	INTERVENTION	86
FIS4-135-30	INTERVENTION	86
FIS4-135-30SQ	INTERVENTION	86
FIS4-135-40	INTERVENTION	86
FIS4-135-40SQ	INTERVENTION	86
FIS4-135-5	INTERVENTION	86
FIS4-135-50	INTERVENTION	86
FIS4-135-50SQ	INTERVENTION	86
FIS4-135-5SQ	INTERVENTION	86
FIS4-45-10	INTERVENTION	86
FIS4-45-10SQ	INTERVENTION	86
FIS4-45-20	INTERVENTION	86
FIS4-45-20SQ	INTERVENTION	86
FIS4-90-10	INTERVENTION	86
FIS4-90-10SQ	INTERVENTION	86
FIS4-90-20	INTERVENTION	86
FIS4-90-20SQ	INTERVENTION	86
FIS4-90-30	INTERVENTION	86
FIS4-90-30SQ	INTERVENTION	86
FIS4-90-40	INTERVENTION	86
FIS4-90-40SQ	INTERVENTION	86
FIS4-90-5	INTERVENTION	86
FIS4-90-50	INTERVENTION	86
FIS4-90-50SQ	INTERVENTION	86
FIS4-90-5SQ	INTERVENTION	86
FIS5-135-10	INTERVENTION	87
FIS5-135-10SQ	INTERVENTION	87
FIS5-135-20	INTERVENTION	87
FIS5-135-20SQ	INTERVENTION	87
FIS5-135-30	INTERVENTION	87
FIS5-135-30SQ	INTERVENTION	87
FIS5-135-40	INTERVENTION	87
FIS5-135-40SQ	INTERVENTION	87
FIS5-135-5	INTERVENTION	87
FIS5-135-50	INTERVENTION	87
FIS5-135-50SQ	INTERVENTION	87
FIS5-135-5SQ	INTERVENTION	87
FIS5-45-10	INTERVENTION	87
FIS5-45-10SQ	INTERVENTION	87
FIS5-45-20	INTERVENTION	87
FIS5-45-20SQ	INTERVENTION	87
FIS5-90-10	INTERVENTION	87
FIS5-90-10SQ	INTERVENTION	87
FIS5-90-20	INTERVENTION	87
FIS5-90-20SQ	INTERVENTION	87
FIS5-90-30	INTERVENTION	87
FIS5-90-30SQ	INTERVENTION	87
FIS5-90-40	INTERVENTION	87
FIS5-90-40SQ	INTERVENTION	87

FIS5-90-5	INTERVENTION	87
FIS5-90-50	INTERVENTION	87
FIS5-90-50SQ	INTERVENTION	87
FIS5-90-5SQ	INTERVENTION	87
FLO30P	INTERVENTION	76
FT-1100	INTERVENTION	84
FW4-135	INTERVENTION	89
FW4-45	INTERVENTION	89
FW4-90	INTERVENTION	89
FW5-135	INTERVENTION	89
FW5-45	INTERVENTION	89
FW5-90	INTERVENTION	89
FZ624	INTERVENTION	69
HPAD22	CPS	109
HVA-100	ACCESS	10
HVA-100	CPS	110
IA-102	INTERVENTION	84
IN4130	INTERVENTION	73
IN7130	INTERVENTION	74
IN8130	INTERVENTION	73
IQ35F150B	ANGIOGRAPHY	13
IQ35F150BC	ANGIOGRAPHY	13
IQ35F150BST	ANGIOGRAPHY	13
IQ35F150J105S	ANGIOGRAPHY	14
IQ35F150J15	ANGIOGRAPHY	14
IQ35F150J1O5	ANGIOGRAPHY	14
IQ35F150J1O5RS	ANGIOGRAPHY	13
IQ35F150J3F	ANGIOGRAPHY	14
IQ35F150J3S	ANGIOGRAPHY	14
IQ35F150J3SHD	ANGIOGRAPHY	14
IQ35F150J6	ANGIOGRAPHY	14
IQ35F150NLLLT	ANGIOGRAPHY	13
IQ35F150NLLT	ANGIOGRAPHY	13
IQ35F150NLT	ANGIOGRAPHY	13
IQ35F150S	ANGIOGRAPHY	13
IQ35F180B	ANGIOGRAPHY	13
IQ35F180BST	ANGIOGRAPHY	13
IQ35F180J1O5	ANGIOGRAPHY	14
IQ35F180J1O5RS	ANGIOGRAPHY	13
IQ35F180J3*	ANGIOGRAPHY	14
IQ35F180J3F	ANGIOGRAPHY	14
IQ35F210J1O5	ANGIOGRAPHY	14
IQ35F260B	ANGIOGRAPHY	13
IQ35F260J1O5	ANGIOGRAPHY	14
IQ35F260J1O5F	ANGIOGRAPHY	14
IQ35F260J3	ANGIOGRAPHY	14
IQ35F260S	ANGIOGRAPHY	13
IQ35F80B	ANGIOGRAPHY	13
IQ35F80J1O5RS	ANGIOGRAPHY	13
IQ35F80J3	ANGIOGRAPHY	14
IQ38F150B	ANGIOGRAPHY	13
IQ38F150BST	ANGIOGRAPHY	13
IQ38F150J15	ANGIOGRAPHY	14
IQ38F150J1O5RS	ANGIOGRAPHY	13
IQ38F150J3	ANGIOGRAPHY	14

IQ38F150J3F	ANGIOGRAPHY	14	IS5-90-40	INTERVENTION	88
IQ38F150J6	ANGIOGRAPHY	14	IS5-90-5	INTERVENTION	88
IQ38F150S	ANGIOGRAPHY	13	IS5-90-50	INTERVENTION	88
IQ38F180J3F	ANGIOGRAPHY	14	K001N	ACCESS	7
IQ38F260J3	ANGIOGRAPHY	14	K01-00786	ANGIOGRAPHY	53
IQ38F260S	ANGIOGRAPHY	13	K01-00917	ANGIOGRAPHY	53
IQH35F150B	ANGIOGRAPHY	13	K01-00953	ANGIOGRAPHY	53
IQH35F150J15	ANGIOGRAPHY	14	K01-03243	ANGIOGRAPHY	53
IQH35F150J1O5	ANGIOGRAPHY	14	K01-05093	ANGIOGRAPHY	53
IQH35F150J3	ANGIOGRAPHY	14	K01-05185	ANGIOGRAPHY	53
IQH35F150J3F	ANGIOGRAPHY	14	K01-07736	ANGIOGRAPHY	56
IQH35F150J3S	ANGIOGRAPHY	14	K01-07736	INTERVENTION	70
IQH35F150NLLT	ANGIOGRAPHY	13	K01-07738	ANGIOGRAPHY	56
IQH35F150NLT	ANGIOGRAPHY	13	K01-07738	INTERVENTION	70
IQH35F150S	ANGIOGRAPHY	13	K01-07739	ANGIOGRAPHY	56
IQH35F180B	ANGIOGRAPHY	13	K01-07739	INTERVENTION	70
IQH35F180J3F	ANGIOGRAPHY	14	K01-07740	ANGIOGRAPHY	56
IQH35F70J6	ANGIOGRAPHY	14	K01-07740	INTERVENTION	70
IQH38F150B	ANGIOGRAPHY	13	K01-60075	ANGIOGRAPHY	53
IQH38F150J3	ANGIOGRAPHY	14	K01-60077	ANGIOGRAPHY	53
IQH38F150J3F	ANGIOGRAPHY	14	K01-60078	ANGIOGRAPHY	53
IQH38F70J6	ANGIOGRAPHY	14	K01-60081	ANGIOGRAPHY	53
IQR35F150B	ANGIOGRAPHY	15	K01-60082	ANGIOGRAPHY	53
IQR35F150BST	ANGIOGRAPHY	15	K01-60083	ANGIOGRAPHY	53
IQR35F150J3	ANGIOGRAPHY	15	K01-60085	ANGIOGRAPHY	53
IQR35F150J3F	ANGIOGRAPHY	15	K01-60086	ANGIOGRAPHY	53
IQR35F150J3S	ANGIOGRAPHY	15	K01-60089	ANGIOGRAPHY	53
IQR35F260J3	ANGIOGRAPHY	15	K01-60090	ANGIOGRAPHY	53
IQR38F150J3	ANGIOGRAPHY	15	K01-60093	ANGIOGRAPHY	53
IQR38F150J3F	ANGIOGRAPHY	15	K01-60094	ANGIOGRAPHY	53
IS4-135-10	INTERVENTION	88	K01-60097	ANGIOGRAPHY	53
IS4-135-20	INTERVENTION	88	K01-60098	ANGIOGRAPHY	53
IS4-135-30	INTERVENTION	88	K01-60099	ANGIOGRAPHY	53
IS4-135-40	INTERVENTION	88	K01-60101	ANGIOGRAPHY	53
IS4-135-5	INTERVENTION	88	K01-60102	ANGIOGRAPHY	53
IS4-135-50	INTERVENTION	88	K01-60105	ANGIOGRAPHY	53
IS4-45-10	INTERVENTION	88	K01-60106	ANGIOGRAPHY	53
IS4-45-20	INTERVENTION	88	K01-60109	ANGIOGRAPHY	53
IS4-90-10	INTERVENTION	88	K01-60110	ANGIOGRAPHY	53
IS4-90-20	INTERVENTION	88	K08-01907	INTERVENTION	69
IS4-90-30	INTERVENTION	88	K08-01961B	ANGIOGRAPHY	51
IS4-90-40	INTERVENTION	88	K08-02027	INTERVENTION	69
IS4-90-5	INTERVENTION	88	K08-02195A	ANGIOGRAPHY	51
IS4-90-50	INTERVENTION	88	K10-00230B	INTERVENTION	69
IS5-135-10	INTERVENTION	88	K10-00576	CPS	107
IS5-135-20	INTERVENTION	88	K10-00577	CPS	108
IS5-135-30	INTERVENTION	88	K10-01103	CPS	108
IS5-135-40	INTERVENTION	88	K10-01555	CPS	108
IS5-135-5	INTERVENTION	88	K10-03450	INTERVENTION	69
IS5-135-50	INTERVENTION	88	K10-04129	INTERVENTION	71
IS5-45-10	INTERVENTION	88	K10-04130	INTERVENTION	71
IS5-45-20	INTERVENTION	88	K10-04750	INTERVENTION	71
IS5-90-10	INTERVENTION	88	K12-00262	INTERVENTION	90
IS5-90-20	INTERVENTION	88	K12-00462	INTERVENTION	89
IS5-90-30	INTERVENTION	88	K12-00463	INTERVENTION	89
			K12-01575	CPS	104

K12T-01721	CPS	105
K12T-01822	CPS	104
K12T-02045	CPS	103
K12T-02843	CPS	102
K12T-02844	CPS	102
K12T-04321	CPS	101
K12T-04322	CPS	101
K12T-07302	CPS	105
K12T-07303	CPS	105
K12T-07304	CPS	105
K12T-07361	CPS	105
K12T-07362	CPS	105
K12T-07363	CPS	105
K12T-07364	CPS	105
K13-00476	ANGIOGRAPHY	54
K16-00002	EMBOLOTHERAPY	96
K16-00003	EMBOLOTHERAPY	96
L3SNC	INTERVENTION	71
L4SNC	INTERVENTION	71
LWSTDA18150	ANGIOGRAPHY	16
LWSTDA18180	ANGIOGRAPHY	16
LWSTDA18260EX	ANGIOGRAPHY	16
LWSTDA1880	ANGIOGRAPHY	16
LWSTDA25150	ANGIOGRAPHY	16
LWSTDA25180	ANGIOGRAPHY	16
LWSTDA25260EX	ANGIOGRAPHY	16
LWSTDA35150	ANGIOGRAPHY	15
LWSTDA35180	ANGIOGRAPHY	15
LWSTDA35260EX	ANGIOGRAPHY	15
LWSTDA38120	ANGIOGRAPHY	15
LWSTDA38150	ANGIOGRAPHY	15
LWSTDA38180	ANGIOGRAPHY	15
LWSTDA38260EX	ANGIOGRAPHY	15
LWSTDA3880	ANGIOGRAPHY	15
LWSTDS18150	ANGIOGRAPHY	16
LWSTDS18180	ANGIOGRAPHY	16
LWSTDS18260EX	ANGIOGRAPHY	16
LWSTDS25150	ANGIOGRAPHY	16
LWSTDS25180	ANGIOGRAPHY	16
LWSTDS25260EX	ANGIOGRAPHY	16
LWSTDS35150	ANGIOGRAPHY	15
LWSTDS35180	ANGIOGRAPHY	15
LWSTDS35220	ANGIOGRAPHY	15
LWSTDS35260EX	ANGIOGRAPHY	15
LWSTDS3580	ANGIOGRAPHY	15
LWSTDS38150	ANGIOGRAPHY	15
LWSTDS38180	ANGIOGRAPHY	15
LWSTDS38260EX	ANGIOGRAPHY	15
LWSTFA35150	ANGIOGRAPHY	16
LWSTFA35180	ANGIOGRAPHY	16
LWSTFA35220	ANGIOGRAPHY	16
LWSTFA35260EX	ANGIOGRAPHY	16
LWSTFA3580	ANGIOGRAPHY	16
LWSTFA38150	ANGIOGRAPHY	16
LWSTFA38180	ANGIOGRAPHY	16
LWSTFA3880	ANGIOGRAPHY	16

LWSTFS3580	ANGIOGRAPHY	16
LWSTFS35150	ANGIOGRAPHY	16
LWSTFS35180	ANGIOGRAPHY	16
LWSTFS35220	ANGIOGRAPHY	16
LWSTFS35260EX	ANGIOGRAPHY	16
LWSTFS38150	ANGIOGRAPHY	16
LWSTFS38180	ANGIOGRAPHY	16
MAK001	ACCESS	7
MAK001N-60	ACCESS	7
MAK001N-80	ACCESS	7
MAK005	ACCESS	7
MAK005-60	ACCESS	7
MAK401	ACCESS	5
MAK401-E	ACCESS	5
MAK401N	ACCESS	5
MAK401NBT	ACCESS	6
MAK401N-E	ACCESS	5
MAK401NEBT	ACCESS	6
MAK401NPD	ACCESS	5
MAK401NPDBT	ACCESS	6
MAK401NPD-E	ACCESS	5
MAK401NPDEBT	ACCESS	6
MAK401N-PED	ACCESS	5
MAK401-PED	ACCESS	5
MAK405	ACCESS	5
MAK405-E	ACCESS	5
MAK405PD	ACCESS	5
MAK4F-10	ACCESS	7
MAK501	ACCESS	5
MAK501-E	ACCESS	5
MAK501N	ACCESS	5
MAK501N-15	ACCESS	5
MAK501NBT	ACCESS	6
MAK501N-E	ACCESS	5
MAK501NEBT	ACCESS	6
MAK501NPD	ACCESS	5
MAK501NPDBT	ACCESS	6
MAK501NPD-E	ACCESS	5
MAK501NPDEBT	ACCESS	6
MAK501N-PED	ACCESS	5
MAK501-PED	ACCESS	5
MAK505	ACCESS	5
MAK505-E	ACCESS	5
MAK505PD	ACCESS	5
MAK5F-10	ACCESS	7
MAK5F-15	ACCESS	7
MAKNTPD	ACCESS	7
MAK-NV-001	INTERVENTION	59
MAK-NV-002	INTERVENTION	59
MAK-NV-003	INTERVENTION	59
MAK-NV-004	INTERVENTION	59
MAK-NV-005	INTERVENTION	59
MAK-NV-006	INTERVENTION	59
MAK-NV-007	INTERVENTION	59
MAK-NV-008	INTERVENTION	59
MAK-NV-009	INTERVENTION	59

MAK-NV-010	INTERVENTION	59	MSS111-R	ANGIOGRAPHY	53
MAK-NV-011	INTERVENTION	59	MSS111-Y	ANGIOGRAPHY	53
MAK-NV-012	INTERVENTION	59	MSS121	ANGIOGRAPHY	53
MAK-NV-013	INTERVENTION	59	MSS121-DG	ANGIOGRAPHY	53
MAK-NV-014	INTERVENTION	59	MSS121-LB	ANGIOGRAPHY	53
MAK-NV-015	INTERVENTION	59	MSS121-LG	ANGIOGRAPHY	53
MAK-NV-016	INTERVENTION	59	MSS121-PR	ANGIOGRAPHY	53
MAK-NV-017	INTERVENTION	59	MSS121-R	ANGIOGRAPHY	53
MAK-NV-018	INTERVENTION	59	MSS121-Y	ANGIOGRAPHY	53
MAK-NV-019	INTERVENTION	59	MSS131	ANGIOGRAPHY	53
MAK-NV-020	INTERVENTION	59	MSS131-DG	ANGIOGRAPHY	53
MAK-NV-021	INTERVENTION	59	MSS131-LB	ANGIOGRAPHY	53
MAKSSPD	ACCESS	7	MSS131-LG	ANGIOGRAPHY	53
MDD100	CPS	106	MSS131-PR	ANGIOGRAPHY	53
MDD110	CPS	106	MSS131-R	ANGIOGRAPHY	53
MDD200	CPS	106	MSS131-Y	ANGIOGRAPHY	53
MDD200H	CPS	106	MSS160	ANGIOGRAPHY	53
MDD220	CPS	106	MSSF011	ANGIOGRAPHY	54
MDD220H	CPS	106	MSSF031	ANGIOGRAPHY	54
MDD300H	CPS	106	MSSF061	ANGIOGRAPHY	54
MDD400H	CPS	107	MSSF111	ANGIOGRAPHY	54
MDD520H	CPS	107	MSSF121	ANGIOGRAPHY	54
MDD520H	CPS	107	MSSF131	ANGIOGRAPHY	54
MDD600	INTERVENTION	69	MSSF160	ANGIOGRAPHY	54
MIC5-135-10-035	INTERVENTION	90	MSSW11	ANGIOGRAPHY	54
MIC5-135-5-035	INTERVENTION	90	MSSW11-DG	ANGIOGRAPHY	54
MIC5-45-10-035	INTERVENTION	90	MSSW11-LB	ANGIOGRAPHY	54
MIC5-45-5-035	INTERVENTION	90	MSSW11-LG	ANGIOGRAPHY	54
MIC5-90-10-035	INTERVENTION	90	MSSW11-PR	ANGIOGRAPHY	54
MIC5-90-5-035	INTERVENTION	90	MSSW11-R	ANGIOGRAPHY	54
MSS011	ANGIOGRAPHY	53	MSSW11-Y	ANGIOGRAPHY	54
MSS011-DG	ANGIOGRAPHY	53	MSSW21	ANGIOGRAPHY	54
MSS011-LB	ANGIOGRAPHY	53	MSSW21-DG	ANGIOGRAPHY	54
MSS011-LG	ANGIOGRAPHY	53	MSSW21-LB	ANGIOGRAPHY	54
MSS011-PR	ANGIOGRAPHY	53	MSSW21-LG	ANGIOGRAPHY	54
MSS011-R	ANGIOGRAPHY	53	MSSW21-PR	ANGIOGRAPHY	54
MSS011-Y	ANGIOGRAPHY	53	MSSW21-R	ANGIOGRAPHY	54
MSS031	ANGIOGRAPHY	53	MSSW21-Y	ANGIOGRAPHY	54
MSS031-DG	ANGIOGRAPHY	53	MVP44	CPS	109
MSS031-LB	ANGIOGRAPHY	53	O684-00-0504	CPS	109
MSS031-LG	ANGIOGRAPHY	53	ONE1000	INTERVENTION	76
MSS031-PR	ANGIOGRAPHY	53	ONE1001	INTERVENTION	76
MSS031-R	ANGIOGRAPHY	53	ONE1500	INTERVENTION	76
MSS031-Y	ANGIOGRAPHY	53	ONE2000	INTERVENTION	76
MSS061	ANGIOGRAPHY	53	ONE2500	INTERVENTION	76
MSS061-DG	ANGIOGRAPHY	53	ONE2501	INTERVENTION	76
MSS061-LB	ANGIOGRAPHY	53	ONE3000	INTERVENTION	76
MSS061-LG	ANGIOGRAPHY	53	ONE3500	INTERVENTION	76
MSS061-PR	ANGIOGRAPHY	53	ONE4000	INTERVENTION	76
MSS061-R	ANGIOGRAPHY	53	ONE500	INTERVENTION	76
MSS061-Y	ANGIOGRAPHY	53	ONE6000	INTERVENTION	76
MSS111	ANGIOGRAPHY	53	OSC-4F-10L	INTERVENTION	65
MSS111-DG	ANGIOGRAPHY	53	OSC-4F-10LNH	INTERVENTION	65
MSS111-LB	ANGIOGRAPHY	53	OSC-4F-10LT	INTERVENTION	65
MSS111-LG	ANGIOGRAPHY	53	OSC-4F-10S	INTERVENTION	65
MSS111-PR	ANGIOGRAPHY	53	OSC-4F-10T	INTERVENTION	65

OSC-4F-7L	INTERVENTION	65
OSC-4F-7LNH	INTERVENTION	65
OSC-4F-7LT	INTERVENTION	65
OSC-4F-7S	INTERVENTION	65
OSC-4F-7T	INTERVENTION	65
OSC-5F-10L	INTERVENTION	65
OSC-5F-10LNH	INTERVENTION	65
OSC-5F-10LT	INTERVENTION	65
OSC-5F-10S	INTERVENTION	65
OSC-5F-10T	INTERVENTION	65
OSC-5F-15L	INTERVENTION	65
OSC-5F-15LNH	INTERVENTION	65
OSC-5F-15LT	INTERVENTION	65
OSC-5F-15S	INTERVENTION	65
OSC-5F-15T	INTERVENTION	65
OSC-5F-7L	INTERVENTION	65
OSC-5F-7LNH	INTERVENTION	65
OSC-5F-7LT	INTERVENTION	65
OSC-5F-7S	INTERVENTION	65
OSC-5F-7T	INTERVENTION	65
PD4F035	ACCESS	7
PD5F038	ACCESS	7
PD6F038	ACCESS	7
PD7F038	ACCESS	7
PD8F038	ACCESS	7
PRO-4F-11-035MT	ACCESS	8
PRO-4F-11MT	ACCESS	8
PRO-5F-11-035MT	ACCESS	8
PRO-5F-11-038MT	ACCESS	8
PRO-5F-11MT	ACCESS	8
PRO-6F-11-035MT	ACCESS	8
PRO-6F-11-038MT	ACCESS	8
PRO-6F-11MT	ACCESS	8
PRO-7F-11-035MT	ACCESS	8
PRO-7F-11-038MT	ACCESS	8
PRO-7F-11MT	ACCESS	8
PRO-8F-11-035MT	ACCESS	8
PRO-8F-11-038MT	ACCESS	8
PRO-8F-11MT	ACCESS	8
PSI-4F-23-035MT	ACCESS	8
PSI-4F-23MT	ACCESS	8
PSI-5F-23-035MT	ACCESS	8
PSI-5F-23-038MT	ACCESS	8
PSI-5F-23MT	ACCESS	8
PSI-6F-23-035MT	ACCESS	8
PSI-6F-23-038MT	ACCESS	8
PSI-6F-23MT	ACCESS	8
PSI-7F-23-035MT	ACCESS	8
PSI-7F-23-038MT	ACCESS	8
PSI-7F-23MT	ACCESS	8
PSI-8F-23-035MT	ACCESS	8
PSI-8F-23-038MT	ACCESS	8
PSI-8F-23MT	ACCESS	8
PSS-5F-4-018MT	ACCESS	9
PSS-5F-4-018MT	INTERVENTION	78

PSS-5F-4-035MT	ACCESS	9
PSS-5F-4-035MT	INTERVENTION	78
PSS-5F-4-038MT	ACCESS	9
PSS-5F-4-038MT	INTERVENTION	78
PSS-5F-4MT	ACCESS	9
PSS-5F-4MT	INTERVENTION	78
PSS-6F-4-018MT	ACCESS	9
PSS-6F-4-018MT	INTERVENTION	78
PSS-6F-4-035MT	ACCESS	9
PSS-6F-4-035MT	INTERVENTION	78
PSS-6F-4-038MT	ACCESS	9
PSS-6F-4-038MT	INTERVENTION	78
PSS-6F-4MT	ACCESS	9
PSS-6F-4MT	INTERVENTION	78
PSS-7F-4-018MT	ACCESS	9
PSS-7F-4-018MT	INTERVENTION	78
PSS-7F-4-035MT	ACCESS	9
PSS-7F-4-035MT	INTERVENTION	78
PSS-7F-4-038MT	ACCESS	9
PSS-7F-4-038MT	INTERVENTION	78
PSS-7F-4MT	ACCESS	9
PSS-7F-4MT	INTERVENTION	78
PSS-8F-4-018MT	ACCESS	9
PSS-8F-4-018MT	INTERVENTION	78
PSS-8F-4-035MT	ACCESS	9
PSS-8F-4-035MT	INTERVENTION	78
PSS-8F-4-038MT	ACCESS	9
PSS-8F-4-038MT	INTERVENTION	78
PSS-8F-4MT	ACCESS	9
PSS-8F-4MT	INTERVENTION	78
RBC-10-038	INTERVENTION	60
RBC-10-REV	INTERVENTION	60
RBC-10-SFX	INTERVENTION	60
RBC-12-038	INTERVENTION	60
RBC-12-REV	INTERVENTION	60
RBC-12-SFX	INTERVENTION	60
RBC-14-038	INTERVENTION	60
RBC-14-REV	INTERVENTION	60
RBC-14-SFX	INTERVENTION	60
RBC-8-038	INTERVENTION	60
RBC-8-REV	INTERVENTION	60
RBC-8-SFX	INTERVENTION	60
RBDC-10-038	INTERVENTION	60
RBDC-10-REV	INTERVENTION	60
RBDC-10-SFX	INTERVENTION	60
RBDC-12-038	INTERVENTION	60
RBDC-12-REV	INTERVENTION	60
RBDC-12-SFX	INTERVENTION	60
RBDC-14-038	INTERVENTION	60
RBDC-14-REV	INTERVENTION	60
RBDC-14-SFX	INTERVENTION	60
RBDC-8-038	INTERVENTION	60
RBDC-8-REV	INTERVENTION	60
RBDC-8-SFX	INTERVENTION	60

RC-RTOOL	INTERVENTION	60	RLCMB-NV-12-REV	INTERVENTION	63
REN1003004	INTERVENTION	75	RLCMB-NV-12-SFX	INTERVENTION	63
RLC-10-038	INTERVENTION	61	RLCMB-NV-14	INTERVENTION	63
RLC-10-038MB	INTERVENTION	61	RLCMB-NV-14-REV	INTERVENTION	63
RLC-10-REV	INTERVENTION	62	RLCMB-NV-14-SFX	INTERVENTION	63
RLC-10-SFX	INTERVENTION	62	RLCMB-NV-6	INTERVENTION	63
RLC-12-038	INTERVENTION	61	RLCMB-NV-6-REV	INTERVENTION	63
RLC-12-038MB	INTERVENTION	61	RLCMB-NV-6-SFX	INTERVENTION	63
RLC-12-REV	INTERVENTION	62	RLCMB-NV-7	INTERVENTION	63
RLC-12-SFX	INTERVENTION	62	RLCMB-NV-7-SFX	INTERVENTION	63
RLC-14-038	INTERVENTION	61	RLCMB-NV-8	INTERVENTION	63
RLC-14-038MB	INTERVENTION	61	RLCMB-NV-8-REV	INTERVENTION	63
RLC-14-REV	INTERVENTION	62	RLCMB-NV-8-SFX	INTERVENTION	63
RLC-14-SFX	INTERVENTION	62	RLC-NV-10	INTERVENTION	63
RLC15-10-038MB	INTERVENTION	61	RLC-NV-10-REV	INTERVENTION	63
RLC15-12-038MB	INTERVENTION	61	RLC-NV-10-SFX	INTERVENTION	63
RLC15-14-038MB	INTERVENTION	61	RLC-NV-12	INTERVENTION	63
RLC15-6-038MB	INTERVENTION	61	RLC-NV-12-REV	INTERVENTION	63
RLC15-7-038MB	INTERVENTION	61	RLC-NV-12-SFX	INTERVENTION	63
RLC15-8-038MB	INTERVENTION	61	RLC-NV-14	INTERVENTION	63
RLC40-10-038MB	INTERVENTION	61	RLC-NV-14-REV	INTERVENTION	63
RLC40-12-038MB	INTERVENTION	61	RLC-NV-14-SFX	INTERVENTION	63
RLC40-14-038MB	INTERVENTION	61	RLC-NV-6	INTERVENTION	63
RLC40-6-038MB	INTERVENTION	61	RLC-NV-6-REV	INTERVENTION	63
RLC40-7-038MB	INTERVENTION	61	RLC-NV-7-REV	INTERVENTION	63
RLC40-8-038MB	INTERVENTION	61	RLC-NV-6-SFX	INTERVENTION	63
RLC-6-038	INTERVENTION	61	RLC-NV-7	INTERVENTION	63
RLC-6-038MB	INTERVENTION	61	RLC-NV-7-REV	INTERVENTION	63
RLC-6-REV	INTERVENTION	62	RLC-NV-7-SFX	INTERVENTION	63
RLC-6-SFX	INTERVENTION	62	RLC-NV-8	INTERVENTION	63
RLC-7-038	INTERVENTION	61	RLC-NV-8-REV	INTERVENTION	63
RLC-7-038MB	INTERVENTION	61	RLC-NV-8-SFX	INTERVENTION	63
RLC-7-REV	INTERVENTION	62	RNL-10-038J	INTERVENTION	64
RLC-7-SFX	INTERVENTION	62	RNL-10-038S	INTERVENTION	64
RLC-8-038	INTERVENTION	61	RNL-12-038J	INTERVENTION	64
RLC-8-038MB	INTERVENTION	61	RNL-12-038S	INTERVENTION	64
RLC-8-REV	INTERVENTION	62	RNL-6-038J	INTERVENTION	64
RLC-8-SFX	INTERVENTION	62	RNL-6-038S	INTERVENTION	64
RLCMB-10-REV	INTERVENTION	62	RNL-7-038J	INTERVENTION	64
RLCMB-10-SFX	INTERVENTION	62	RNL-7-038S	INTERVENTION	64
RLCMB-12-REV	INTERVENTION	62	RNL-8-038J	INTERVENTION	64
RLCMB-12-SFX	INTERVENTION	62	RNL-8-038S	INTERVENTION	64
RLCMB-14-REV	INTERVENTION	62	S1010EG	EMBOLOTHERAPY	93
RLCMB-14-SFX	INTERVENTION	62	S1010GH	EMBOLOTHERAPY	93
RLCMB-6-REV	INTERVENTION	62	S1020EG	EMBOLOTHERAPY	93
RLCMB-6-SFX	INTERVENTION	62	S1020GH	EMBOLOTHERAPY	93
RLCMB-7-REV	INTERVENTION	62	S120EG	EMBOLOTHERAPY	93
RLCMB-7-SFX	INTERVENTION	62	S120GH	EMBOLOTHERAPY	93
RLCMB-8-REV	INTERVENTION	62	S210EG	EMBOLOTHERAPY	93
RLCMB-8-SFX	INTERVENTION	62	S210GH	EMBOLOTHERAPY	93
RLCMB-NV-10	INTERVENTION	63	S220EG	EMBOLOTHERAPY	93
RLCMB-NV-10-REV	INTERVENTION	63	S220GH	EMBOLOTHERAPY	93
RLCMB-NV-10-SFX	INTERVENTION	63	S410EG	EMBOLOTHERAPY	93
RLCMB-NV-12	INTERVENTION	63	S410GH	EMBOLOTHERAPY	93

S420EG	EMBOLOTHERAPY	93
S420GH	EMBOLOTHERAPY	93
S610EG	EMBOLOTHERAPY	93
S610GH	EMBOLOTHERAPY	93
S620EG	EMBOLOTHERAPY	93
S620GH	EMBOLOTHERAPY	93
S810EG	EMBOLOTHERAPY	93
S810GH	EMBOLOTHERAPY	93
S820EG	EMBOLOTHERAPY	93
S820GH	EMBOLOTHERAPY	93
SC14135	INTERVENTION	72
SC14150	INTERVENTION	72
SC1465	INTERVENTION	72
SC1490	INTERVENTION	72
SC18135	INTERVENTION	72
SC18150	INTERVENTION	72
SC1865	INTERVENTION	72
SC1890	INTERVENTION	72
SC35135	INTERVENTION	72
SC35150	INTERVENTION	72
SC3565	INTERVENTION	72
SC3590	INTERVENTION	72
SCV22P-AB	CPS	109
S-MAK401	ACCESS	6
S-MAK401N	ACCESS	6
S-MAK401NBT	ACCESS	6
S-MAK401NPD	ACCESS	6
S-MAK401NPDBT	ACCESS	6
S-MAK405	ACCESS	6
S-MAK4F-10	ACCESS	7
S-MAK501	ACCESS	6
S-MAK501N	ACCESS	6
S-MAK501N-15	ACCESS	6
S-MAK501N15BT	ACCESS	6
S-MAK501NBT	ACCESS	6
S-MAK501NPD	ACCESS	6
S-MAK501NPDBT	ACCESS	6
S-MAK505	ACCESS	6
S-MAK5F-10	ACCESS	7
S-MAK5F-15	ACCESS	7
SPPT-100	INTERVENTION	66
SPPT-5F-10L	INTERVENTION	66
SPPT-5F-10S	INTERVENTION	66
SPPT-5F-7L	INTERVENTION	66
SPPT-5F-7S	INTERVENTION	66
SRD100	INTERVENTION	85
SRD200	INTERVENTION	85
TAPS-100	INTERVENTION	67
TAPS-5F-10LT	INTERVENTION	67
TAPS-5F-10T	INTERVENTION	67
TAPS-5F-7LT	INTERVENTION	67
TAPS-5F-7T	INTERVENTION	67
TD100	ANGIOGRAPHY	18
TD200	ANGIOGRAPHY	18

TD500	ANGIOGRAPHY	18
TE-1000	INTERVENTION	84
TNR2411	ANGIOGRAPHY	17
TNR2411	EMBOLOTHERAPY	96
TNR2412	ANGIOGRAPHY	17
TNR2412	EMBOLOTHERAPY	96
TNR2811	ANGIOGRAPHY	17
TNR2811	EMBOLOTHERAPY	96
TNR2812	ANGIOGRAPHY	17
TNR2812	EMBOLOTHERAPY	96
TS120	ANGIOGRAPHY	51
TS220	ANGIOGRAPHY	51
TS520L	ANGIOGRAPHY	51
U1SHC	ANGIOGRAPHY	51
V100EP	EMBOLOTHERAPY	94
V1010GH	EMBOLOTHERAPY	93
V1020GH	EMBOLOTHERAPY	93
V1100EP	EMBOLOTHERAPY	94
V110GH	EMBOLOTHERAPY	93
V120GH	EMBOLOTHERAPY	93
V200EP	EMBOLOTHERAPY	94
V210GH	EMBOLOTHERAPY	93
V220GH	EMBOLOTHERAPY	93
V225HS	ONCOLOGY	98
V300EP	EMBOLOTHERAPY	94
V325HS	ONCOLOGY	98
V400EP	EMBOLOTHERAPY	94
V410GH	EMBOLOTHERAPY	93
V420GH	EMBOLOTHERAPY	93
V525HS	ONCOLOGY	98
V600EP	EMBOLOTHERAPY	94
V610GH	EMBOLOTHERAPY	93
V620GH	EMBOLOTHERAPY	93
V725HS	ONCOLOGY	98
V800EP	EMBOLOTHERAPY	94
V810GH	EMBOLOTHERAPY	93
V820GH	EMBOLOTHERAPY	93
VA-40	INTERVENTION	59
VP-210	INTERVENTION	84
VP-511	INTERVENTION	84

PRODUCT NAME INDEX

30 cm Catheters	79	Stopcocks	71
Access Safety Kit	10	Support Catheters	72
Biopsy Centesis Kits	101	Suture Retention Device	85
Catheter Extraction Tool	83	Syringes	53-56
Catheter Repositioning Tool	60	Therapeutic Infusion Systems	86-87
Catheter Securement Devices	68	Thoracentesis and Paracentesis Set	67
Centesis Catheters	65	Torque Devices	18
Connecting Tubes	71	Vacuum Pressure Syringes	56, 70
Contrast Transfer Sets	51	Valved Adapter	76
Curved Needles	77	Vein Closure Tray & Syringe	104
Diagnostic Guide Wires	13-17	Waste Bags	106-108
Diagnostic Peripheral Catheters	20-50		
Dialysis Catheters	80-82		
Dilators	7		
Drainage Bags & Kits	69		
Drainage Catheters	60-64		
Drainage Tubing	71		
Embolc Delivery Tools	95-96		
Embolisation Particles	94		
Fluid Dispensing Systems	89		
Guide Wire Insertion Device	10		
Haemostasis Pad	109		
Haemostasis Pad with Antimicrobial Barrier	109		
Haemostasis Valve Adapter	110		
High Pressure Flow Control Switch	51		
Inflation Devices	73-74		
Infusion Catheters	88, 90		
Infusion Kits	89-90		
Introducers	8-9		
Medication Delivery Packs	102		
Microcatheters	52, 95		
Microspheres	93, 98		
Myelogram Tray	103		
Occluding Wires	89		
Patient Cover	105		
Peritoneal Dialysis Accessories & Implantation Systems	84		
Peritoneal Dialysis Catheters	83		
Pressure Assisted Device	109		
Safety Paracentesis Procedure Tray	66		
Scatter Radiation Drapes	105		
Short Sheath Introducers	9, 78		
Snares	75-76		